

BLITZ GLASS

Pool Fencing Installation & Accessories



www.blitzglass.com.au



(07) 5493 9779



admin@blitzglass.com.au



EXTRAS & ACCESSORIES

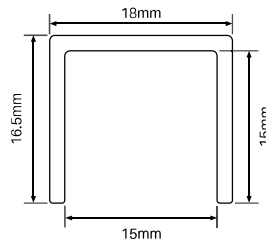
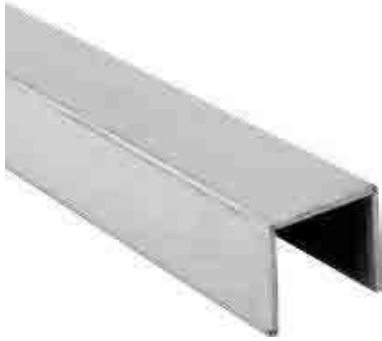

18x16.5mm Summit capping rail

SS316L – 3000mm long

Polish or satin finish

Order Code: STG-U3000-1515-P (Polish)

STG-U3000-1515-S (Satin)

- 15x15mm glazing pocket
- Ideal for capping on top of glass to protect top edge or to brace panels together
- Adhere rail to glass with glazing silicone
- Not balustrade compliant

GLASS & STAINLESS STEEL CARE



Enduroshield glass treatment

125ml or 500ml bottle
Order Code: ENDURO-GC-125 (125ml)
ENDURO-GC-500 (500ml)

- Covers up to 8sqm with 125ml bottle or up to 32sqm with 500ml bottle
- Water and oil repellent
- One application lasts 3+ years
- Kit includes pre-cleaner product & surface treatment
- Cuts cleaning time by up to 90%

Kit includes:

125ml or 500ml Enduroshield glass home surface treatment
EnduroClean pre-cleaner
Fine steel wool
Polishing cloth
Step by step instructions
3 year limited warranty



Enduroshield stainless steel protective coating

60mL bottle
Order Code: ENDURO-SSC-60

- Internal surfaces: Covers up to 4sqm
- External surfaces: Covers up to 2sqm (2 coats required)
- Water and oil repellent
- One application lasts 3+ years
- Kit includes pre-cleaner product & surface treatment
- Cuts cleaning time by up to 90%

Kit includes:

60mL Enduroshield protective coating
125mL EnduroClean pre-cleaner
Microfiber cloth
Polishing cloth
Step by step instructions
3 year limited warranty



Enduroshield stainless steel restore

500mL bottle
Order Code: ENDURO-SSRES

- Specially formulated to remove corrosion and tea staining
- Prepares surface for Enduroshield protective coating
- Apply either directly to the stainless surface or to a damp cloth and wipe over surface with cloth
- Ensure application is with the grain of the stainless steel, not against it

EXTRAS & ACCESSORIES

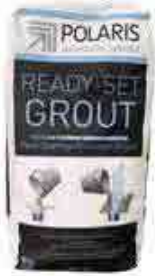

Polaris grout

10kg bag
Order Code: **GROUT-POL-10KG**

- Non shrink grout
- Rapid setting
- Aggregate free



Bostik HES grout

20kg bag
Order Code: **GROUT-BOS**
• Non shrink grout



Sika HES grout

20kg bag
Order Code: **GROUT-SIKA**
• Non shrink grout



Rapid set concrete

20kg bag
Order Code: **GROUT-RSC**



Perth only

KWIKSET concrete

20kg bag
Order Code: **GROUT-KWIKSET**



Ultraloc Threadlocker 3242 compound

10ML BOTTLE
• Medium strength removable grade threadlocking compound for metal screws, nuts and fasteners from 6mm to 20mm in diameter
Order Code: **ULTRALOC-3242**



Vinyl wedge roller

• Ideal for rolling wedge rubber
Order Code: **VROLLER**

Quick grip gloves

• One size fits all
• Pair of gloves
Order Code: **GLOVE**
*Not to be used in wet conditions



CPR sign

• Genuine Royal Life Saving QLD resuscitation chart
• Plastic coated
Order Code: **CPR**



Bostik V60 Clear glazing silicone

300g
Order Code: **FB-V60**
• Translucent
• Architectural grade high performance glazing silicone
• Neutral cure sealant
• Excellent adhesion and flexibility
• Seals water tight – UV and weather resistant
• 25 year manufacturer's guarantee against cracking and crumbling when used in standard conditions and applications*
• Compatible substrates glass, steel, timber, concrete, ceramic, fibreglass, aluminium (powder coated surfaces are limited)



Soudal Epofix 82A

24ml
Order Code: **SODU-EPOFIX**
• 24mL bottle – easy to use dual cartridge
• Translucent fast curing 2 part epoxy
• Very strong bonding of many types of materials. Including metal, wood, glass and plastics

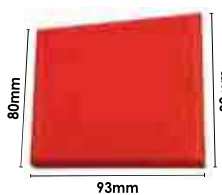

Silicone Spatula

Medium flexibility
Order Code: **P-SS**
• Handy tool for glazing panels with silicone
• Made from thermoplastic polyurethane – good elasticity and resistant to oils, grease & abrasion
• One corner features radius (R4) for neat silicone finishing



EXTRAS & ACCESSORIES



Soudal silicone

TRANSLUCENT – 300mL
Order Code: SOUD-KBS-TRANS

- Translucent finish
- High quality, neutral cure silicone
- Easy to smooth & finish
- For sealing, waterproofing and bonding applications
- Contains mould & mildew inhibitors
- Colourfast and UV resistant
- Strong adhesion to glass, tile, ceramics, aluminium, metals (including powder-coated & anodised), painted surfaces, fibreglass, stainless steel
- Use standard caulking gun



Soudal silicone

WHITE – 300mL
Order Code: SOUD-KBS-W

- White finish
- High quality, neutral cure silicone
- Easy to smooth & finish
- For sealing, waterproofing and bonding applications
- Contains mould & mildew inhibitors
- Colourfast and UV resistant
- Strong adhesion to glass, tile, ceramics, aluminium, metals (including powder-coated & anodised), painted surfaces, fibreglass, stainless steel
- Use standard caulking gun



Soudal all purpose silicone

300mL
Order Code: SOUD-APS-B

- Black finish
- High quality, neutral cure silicone
- Ultimate all rounder silicone (roof/gutter, kitchen/bathroom, glass/glazing)
- Sealing, waterproofing & bonding applications
- Strong adhesion to ceramics, glass, aluminium (including powder coated & anodised), PVC, stainless steel, zinc & galvanised coated surfaces, timber, concrete, fibreglass, laminate, painted surfaces, etc
- UV resistant with very good mould resistance (biocide with fungicidal action)
- Water potable & food safe
- Use standard caulking gun



Soudafix CA 1400 Chemical anchor

280mL
Order Code: SOUD-CA1400

- High performance, two-component chemical anchoring resin for the pressure-free securing of anchoring rods, studs, treaded collars etc
- Easy to use and apply
- Fast cure (20°C=45min full cure; 30°C=25min full cure)
- Vinyl ester styrene free
- Can be used in damp concrete
- Apply with standard caulking gun



Soudal heavy duty cartridge gun

Order Code: SOUD-GUN

- Heavy duty, steel trade quality cartridge gun
- Geared ratio 18:1 for smooth operation and easy application
- Dripless system feature automatically releases pressure to reduce mess/waste
- Suits 300ml silicone cartridges and 280ml chemical anchor

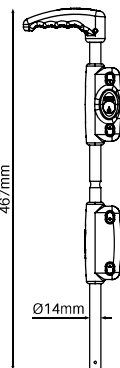

D&D Premium lockable drop bolt

Black finish

Order Code: LB-PL

D&D code: LL118BX-LA

- 316 marine-grade stainless steel drop-rod
- Tough polymer-housing mounting system
- 6-pin lock (rekeyable to match doors & gate locks)

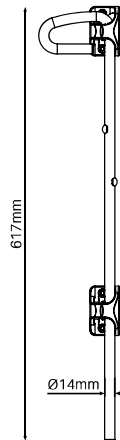

D&D Padlockable drop bolt

Black finish

Order Code: QB124

D&D code: QB124

- Powder coated black, stainless steel drop-bolt
- Padlockable (*Padlock not included)
- Tough, moulded polymer mounting system



300mm drop bolt

Black or zinc plated finish

Order Code: SS-0300DB-B/ZP

- Ideal for driveway gates
- Cost effective drop bolt
- Easy to install

EXTRAS & ACCESSORIES

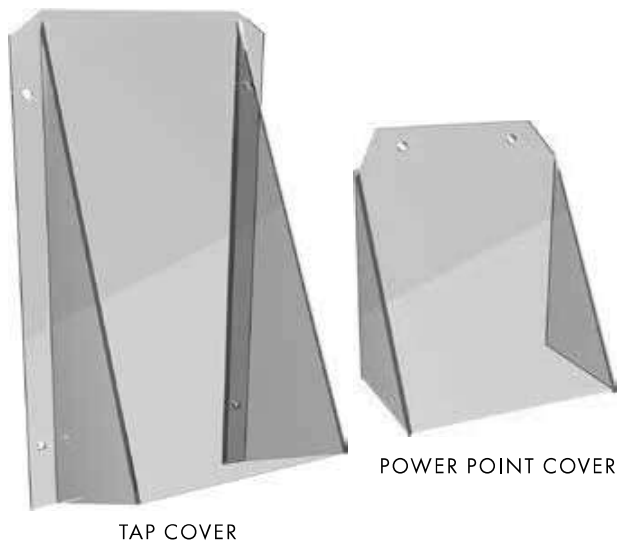

TAP COVER SPECIFICATION

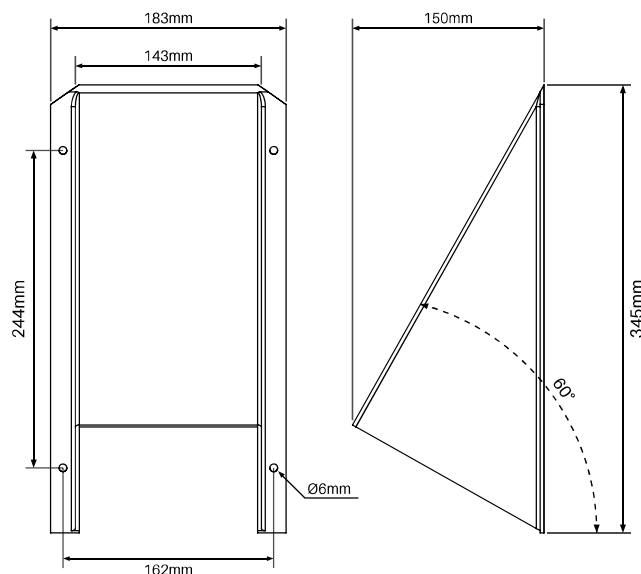

Toe hold prevention covers

THERMOPLASTIC

Transparent finish

Order Code: **COVER-POWER** (Power point cover)
COVER-TAP (Tap cover)

- Transparent thermoplastic
- Cover features 60 degree angle to prevent a toe hold
- Ideal solution if tap or power point considered a step point
- Resistant to impact & chemicals
- Power point cover comes with 2 x predrilled fixing hole
Includes 2 x SS316 screws (ST5x40mm) & 2 x wall plugs
- Tap cover comes with 4 x predrilled fixing hole
Includes 4 x SS316 screws (ST5x40mm) & 4 x wall plugs

POWER POINT COVER SPECIFICATION

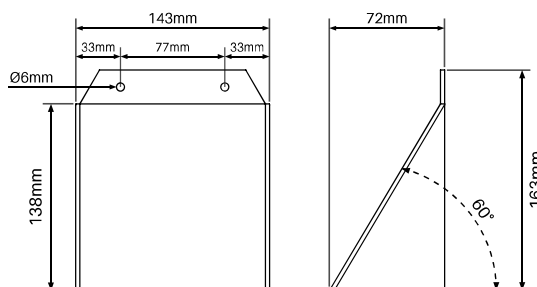

Self drilling tek screws

12Gx20mm – BAG OF 100

Black, woodland grey, monument, primrose, paperbark, silver, surfmist & white

Order Code: **SS-TS-100-B** (Black)

SS-TS-100-G (Woodland grey)

SS-TS-100-MN (Monument)

SS-TS-100-P (Primrose)

SS-TS-100-PB (Paperbark)

SS-TS-100-S (Silver)

SS-TS-100-SM (Surfmist)

SS-TS-100-W (White)

- Self drilling tek screw featuring integrated thread and drill/cutting tip
- 12G x 20mm tek screw with hex head
- Used in a variety of aluminium fencing applications
- Packed in convenient bags of 100 screws
- Available in a variety of powder coated head finishes – thread and tip not powder coated to ensure proper threading/cutting



Conveniently packed in bags of 100 tek screws



EXTRAS & ACCESSORIES



Post plugs

4 PACK

Order code: SS-POSTPLUG-4PK

SS-POSTPLUG-4PK-W (White)

- Ø32mm outer top suits 25mm hole
- Ideal for covering hole in post when affixing post to wall with inner fixing
- Suits post wall thickness 1.5mm – 3.2mm



1 Drill a 25mm diameter hole through front wall of post



2 Drill rear wall of post with required diameter for fixing and then fix post to wall. Insert appropriate fixing into the wall for affixing post



3 Once post is fixed to wall with appropriate fixing method, insert post plug to cover the post hole.



4 Repeat the process as required



Touch up paint

150g SPRAY CAN

Black / Monument / Woodland grey
Silver / Surfmist / White / Basalt / Dune

Order Code:

PAINT-B/G/MN/S/SM/W/BS/D

- Colour match touch up paint
- Simply spray on for minor touch ups



Self drilling wafer screws

10Gx16mm – BAG OF 100

Black / Monument / Woodland grey
Silver / Surfmist / White / Basalt
Dune / Mill finish

Order Code: XP-SCREWS

- Bags of 100 – 10G x 16mm self drilling wafer head zinc plated
- Powder coated heads for neat finish
- Self drilling screws can be used in a variety of install applications



100mm support foot

HEIGHT ADJUSTABLE
SS316 / POLISH FINISH

Order Code: XP-FOOT-ADJ

- Height adjustable support foot
- Easily height adjustable (from 25mm up to 100mm) – stainless steel stem can be cut down and bottom flange reattached with grub screw
- Handy foot for supporting products that have a wide span

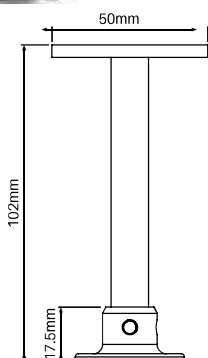

Horseshoe Packers

Black finish

Order Code: HSP-75X38-1MM-20PK

1mm thick – Pack of 20

HSP-75X38-3MM-20PK

3mm thick – Pack of 20

HSP-75X38-10MM-5PK

10mm thick – Pack of 5

- 38mm wide x 75mm long horseshoe packers
- 10.5mm slot
- Available in 1mm or 3mm thick (20 per pack)
- Available in 10mm thick (5 per pack)
- Durable black solid polypropylene
- Handy for levelling adjustments while installing
- Easy to cut down to required length

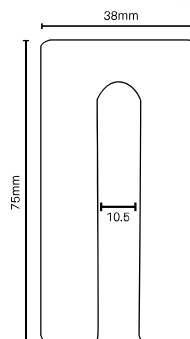

Available 1mm, 3mm or 10mm thick



EXTRAS & ACCESSORIES

We offer a range of stainless steel 316 M10 and M12 fixings perfect for affixing spigots, wall plates, standoffs, rigi and glass clamps

M10 FIXINGS

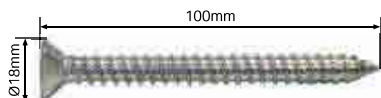

Counter sunk timber screw – 4 pack

100MM LONG – SS316

(Hex head drive)

Order Code: CSK-100-4PK

- Heavy duty self tapping screw - 100mm long with M10 thread - Ø18mm outer head
- Hex head drive
- Ideal for fixing base plated spigots to timber deck
- Countersunk head allows screw to finish flush with top edge of base plate for neat finish

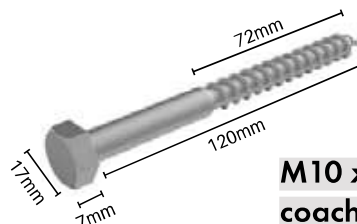

M10 x 120mm hex coach screw

SS316

- Use if base plating to timber substrate
- Ensure timber substrate is suitable for fixing to
- Sold as single screw

Order Code: S-120COACH



Timber fixing kit

4 PACK – SS316

Order Code: S-110LAG-4PK

- M10 x 110mm timber lag screws x4 with nuts and washers
- Nuts fit under high domical covers. Fixing kit cannot be used with slimline covers (slimline covers use countersunk fixings)
- Nut is 8mm thick



Concrete fixing kit

4 PACK – SS316

Order Code: S-120ROD-4PK

- M10 x 120mm concrete threaded rods x4 with nuts and washers
- Nuts fit under high domical covers. Fixing kit cannot be used with slimline covers (slimline covers use countersunk fixings)
- Nut is 8mm thick

BATTEN SCREWS

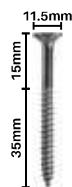

50mm CSK batten screw

SS316

14 gauge

Order Code: CSK-050



75mm CSK batten screw

SS316

14 gauge

Order Code: CSK-075

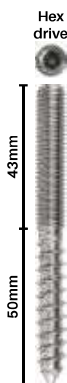

93mm lag screw

SS304

M12 thread

Order Code: GS093LAG

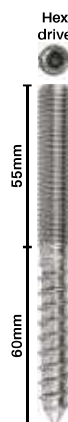

115mm lag screw

SS304

M12 thread

Order Code: GS115LAG



160mm lag screw

SS304

M12 thread

Order Code: GS160LAG

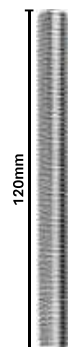

120mm threaded rod

SS304

M12 thread

Order Code: GS120ROD

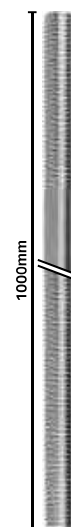

1000mm threaded rod

SS304

M12 thread

Order Code: GS1000ROD



M12 dome nut

PACK OF 4 – SS316

Black or Silver finish

Order Code: GS-DN-4PK (Silver)
GS-DN-4PK-B (Black)

- 4x dome nuts & 4x split washers
- Suits M12 thread



DIAMOND REVOLUTION DRILL



Installation tip

Speed setting 1: Use with 76mm or larger core drill bits
Speed setting 2: Use with 63mm or smaller core drill bits



Diamond revolution stand

Suits diamond revolution core drill

Order Code: REV-STAND

- Steel and aluminium construction
- Height: 800mm
- Base: 330mm x 380mm
- Weight: 12.6kg

Diamond revolution drill

Core drill

Order Code: REV-CD-2S

- 2 speed core drill - 1500W
- Comes with case, allen key, spare set of brushes and manual
- Safety switch
- Uses common size 1 1/4" UNC male thread for diamond core bits

Technical data

Voltage: 240V

Rated frequency: 50-60Hz

Rated input power: 1500W

No load speed r/min: 2100/950

Weight: 8.8kg



Core drill template

Order Code: REV-TEMPLATE

- Assists with starting to core drill hole
- Stabilises the drill bit from jumping



Spirit level for core drill

Order Code: REV-LEVEL

- Screws into core drill machine
- Assists with drilling accurate holes



Splash guard/ water trap

Order Code: REV-GUARD



Base for stand

Order Code: REV-BASE

- 550mm x 550mm overall dimensions

Core drill bits Mild steel body & diamond impregnated crown tip



8mm mini core drill bit

Order Code: REV-BIT-08



10mm mini core drill bit

Order Code: REV-BIT-10



12mm mini core drill bit

Order Code: REV-BIT-12



14mm mini core drill bit

Order Code: REV-BIT-14



20mm mini core drill bit

Order Code: REV-BIT-20



53mm core drill bit

53mm x 450mm long
Order Code: REV-BIT-53



63mm core drill bit

63mm x 450mm long
Order Code: REV-BIT-63



76mm core drill bit

76mm x 450mm long
Order Code: REV-BIT-76



83mm core drill bit

83mm x 450mm long
Order Code: REV-BIT-83



89mm core drill bit

89mm x 450mm long
Order Code: REV-BIT-89