

BLITZ GLASS

**Showers
Hardware &
Accessories**



www.blitzglass.com.au



(07) 5493 9779



admin@blitzglass.com.au





HINGES

Suits 8mm & 10mm glass panels

1 Optimised hinge plate
Hinge plate hole distance optimised for maximum clamping action

2 Grub screws secured with Loctite
For precaution, Loctite is used to secure threaded grub screws

3 Allen key head screws
For ease of installation and to minimise scratching caused by flat head screwdrivers, allen key head screws are used



FREE plastic screw cap covers included

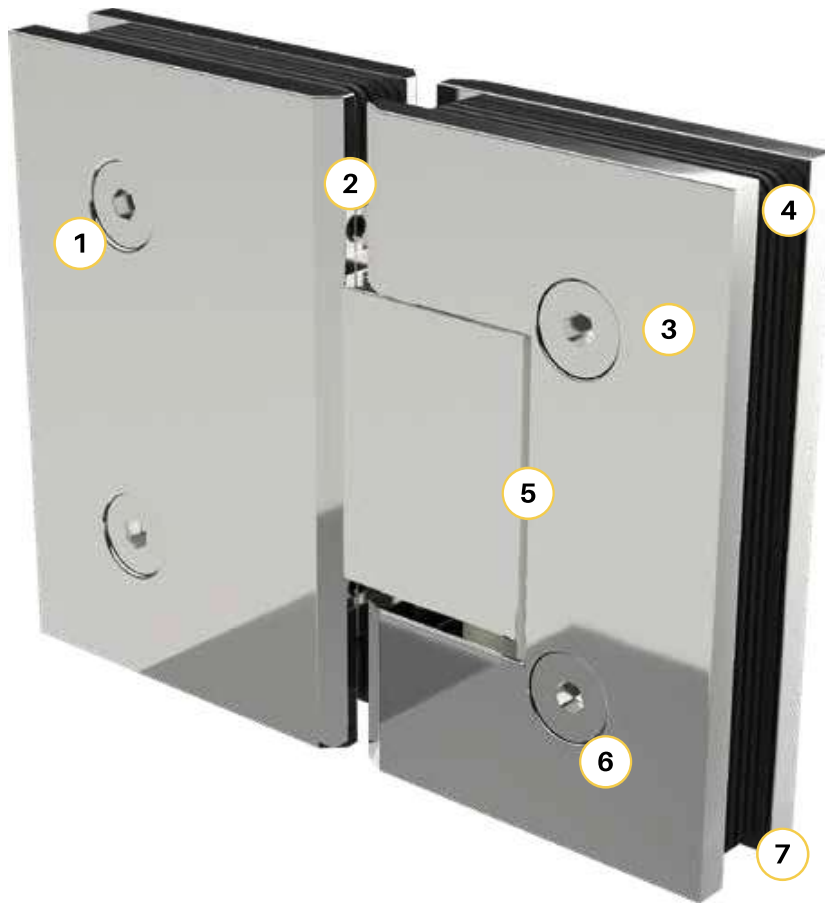

GLASS CUT OUT DETAIL

This cut out applies to all hinges excluding heavy duty hinges & 6mm Zurich hinges

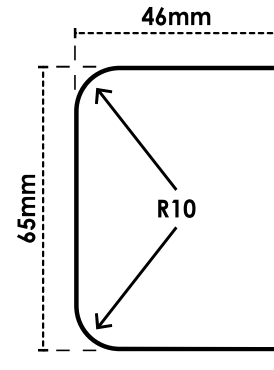

4 Superior quality EPDM gaskets
Gaskets are preglued to the hinges and overlapping plates for easy installation



5 Scratch protectors
Neatly positioned protectors to prevent issues when hinge opens and closes



6 Knurled back screws
Advantage of superior locking action to prevent screws working loose



7 Smart clamping plate design
Recessed clamping plate ensures perfect fit to hinge body



Spring design
Durable tempered stainless steel spring



Sealed spring cavity
Innovative hinge design allows spring cavity to be completely sealed which prevents water penetration into cavity





PURITY HINGES

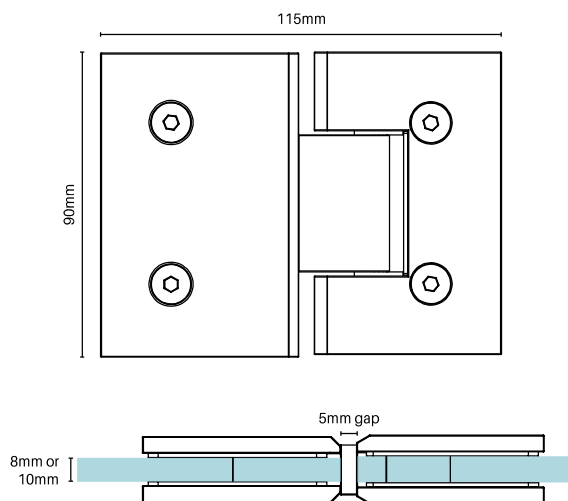

Purity Showerscreens™ glass to glass hinge

SQUARE EDGE

Chrome plated, matt black, brushed brass/gold, matt white, gunmetal & brushed nickel finish

Order Code: PB-H-180 (Bianco – Chrome)

PN-H-180 (Nero – Black)

P-ORO-H-180 (Oro – Brushed Brass/Gold)

P-SNO-H-180 (Sno – White)

P-GIO-H-180 (Gio – Gunmetal)

P-NIKL-H-180 (Nikl – Brushed Nickel)

- Square finish edges
- Suitable for 8mm and 10mm glass
- "D" style glass cutouts
- Self closing from approximately 25°
- Dual action - opens inwards and outwards
- Manufactured in solid brass
- Allen key and gaskets included
- Specially designed strong clamping plate with pre-glued EPDM gasket

Max door weight	35kg per pair
Max door width	800mm



ZÜRICH HINGES

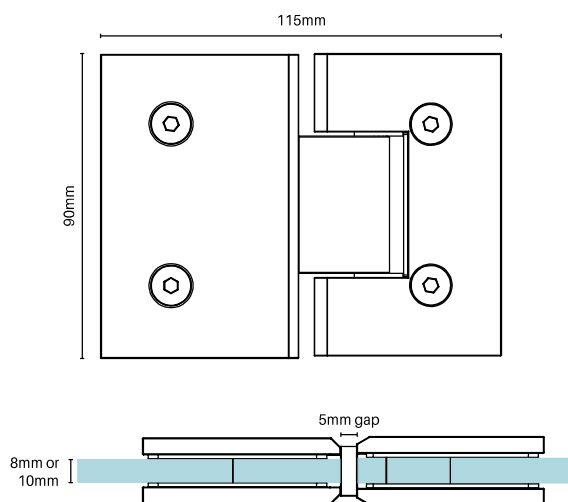

Zürich glass to glass hinge

SQUARE EDGE

Chrome plated or pearl satin chrome finish

Order Code: ZUR-H-180 (Chrome)

ZUR-PEARL-H-180 (Pearl satin)

- Outstanding price point
- Square finish edges
- Suitable for 8mm and 10mm glass
- "D" style glass cutouts
- Self closing from approximately 25°
- Dual action - opens inwards and outwards
- Brass centre block with solid precision clamping plates
- Special tempered SS304 square spring coil. Provides consistent long lasting opening and closing function
- Allen key and gaskets included
- Specially designed strong clamping plate with pre-glued EPDM gasket

Max door weight	35kg per pair
Max door width	800mm





PURITY HINGES

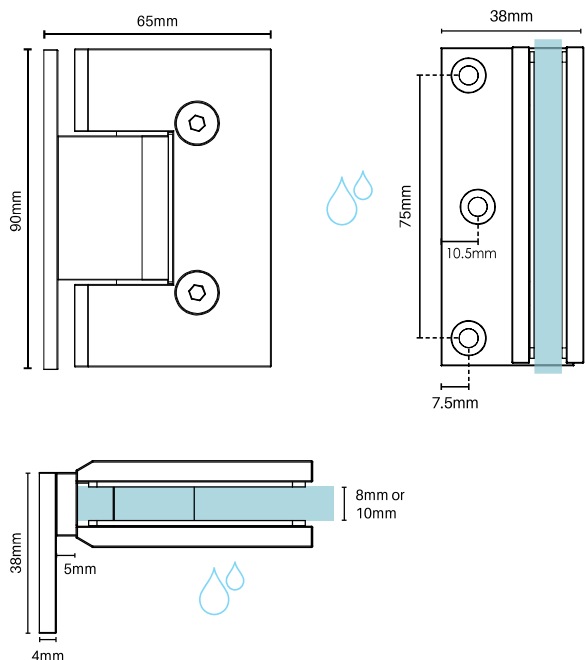

Purity Showerscreens™ offset wall to glass hinge

SQUARE EDGE

Chrome plated, matt black, brushed brass/gold, matt white, gunmetal & brushed nickel finish

Order Code: PB-H-OP (Bianco – Chrome)

PN-H-OP (Nero – Black)

P-ORO-H-OP (Oro – Brushed Brass/Gold)

P-SNO-H-OP (Sno – White)

P-GIO-H-OP (Gio – Gunmetal)

P-NIKL-H-OP (Nikl – Brushed Nickel)

- Offset wall plate with 3x fixing holes – Square finish edges
- Suitable for 8mm and 10mm glass
- "D" style glass cutouts
- Self closing from approximately 25°
- Dual action – opens inwards and outwards
- Manufactured in solid brass
- 3x fixing screws, allen key and gaskets included
- Specially designed strong clamping plate with pre-glued EPDM gasket

Max door weight 35kg per pair

Max door width 800mm



BIANCO

NERO

ORO

SNO

GIO

NIKL

ZÜRICH HINGES

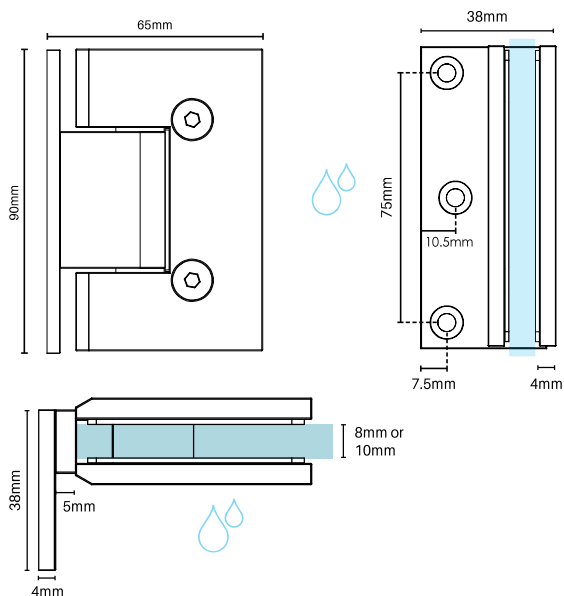

Zürich offset wall to glass hinge

SQUARE EDGE

Chrome plated or pearl satin chrome finish

Order Code: ZUR-H-OP (Chrome)

ZUR-PEARL-H-OP (Pearl satin)

- Outstanding price point
- Offset wall plate with 3x fixing holes – Square finish edges
- Suitable for 8mm and 10mm glass
- "D" style glass cutouts
- Self closing from approximately 25°
- Dual action – opens inwards and outwards
- Brass centre block & wall plate with solid precision clamping plates
- Special tempered SS304 square spring coil. Provides consistent long lasting opening and closing function
- 3x fixing screws, allen key and gaskets included
- Specially designed strong clamping plate with pre-glued EPDM gasket

Max door weight 35kg per pair

Max door width 800mm

PEARL SATIN



CHROME



PURITY HINGES

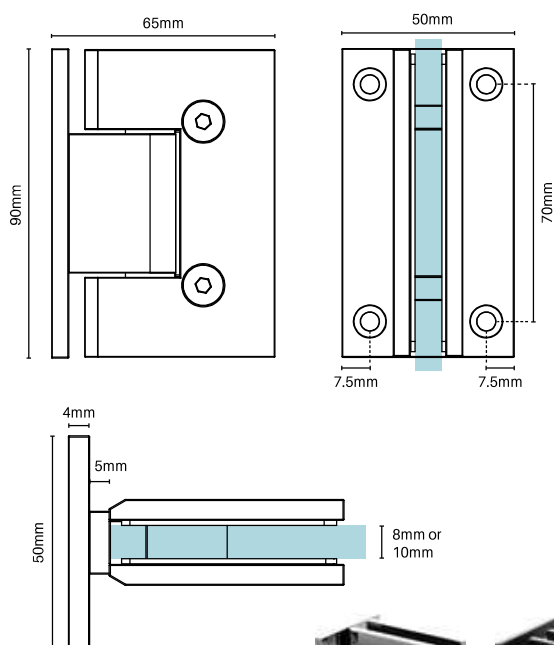

Purity Showerscreens™ wall to glass hinge

SQUARE EDGE

Chrome plated, matt black, brushed brass/gold, matt white, gunmetal & brushed nickel finish

Order Code: PB-H-WP (Bianco – Chrome)

PN-H-WP (Nero – Black)

P-ORO-H-WP (Oro Brushed Brass/Gold)

P-SNO-H-WP (Sno – White)

P-GIO-H-WP (Gio – Gunmetal)

P-NIKL-H-WP (Nikl – Brushed Nickel)

- Wall plate with 4x fixing holes – Square finish edges
- Suitable for 8mm and 10mm glass
- "D" style glass cutouts
- Self closing from approximately 25°
- Dual action – opens inwards and outwards
- Manufactured in solid brass
- 4x fixing screws, allen key and gaskets included
- Specially designed strong clamping plate with pre-glued EPDM gasket

Max door weight 35kg per pair

Max door width 800mm



ZÜRICH HINGES

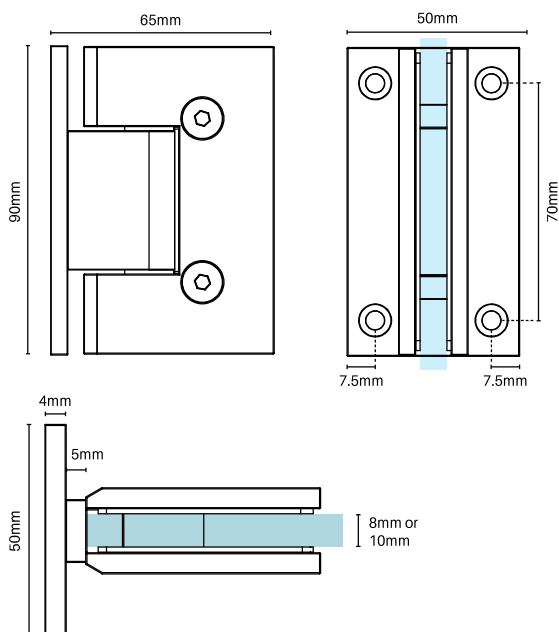

Zürich wall to glass hinge

SQUARE EDGE

Chrome plated or pearl satin chrome finish

Order Code: ZUR-H-WP (Chrome)

ZUR-PEARL-H-WP (Pearl satin)

- Outstanding price point
- Wall plate with 4x fixing holes – Square finish edges
- Suitable for 8mm and 10mm glass
- "D" style glass cutouts
- Self closing from approximately 25°
- Dual action – opens inwards and outwards
- Brass centre block & wall plate with solid precision clamping plates
- Special tempered SS304 square spring coil. Provides consistent long lasting opening and closing function
- 4x fixing screws, allen key and gaskets included
- Specially designed strong clamping plate with pre-glued EPDM gasket

Max door weight 35kg per pair

Max door width 800mm

PEARL SATIN



CHROME



PURITY HINGES

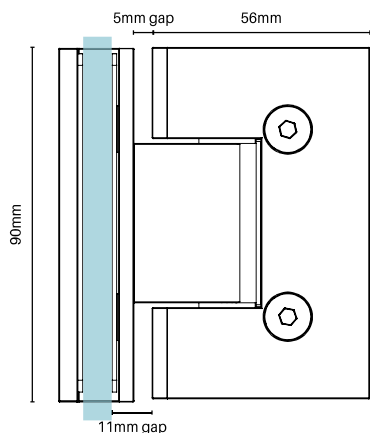

Purity Showercreens™ 90° glass to glass hinge

SQUARE EDGE

Matt black finish

Order Code: PN-H-90 (Nero – Black)

- Square finish edges
- Suitable for 8mm and 10mm glass
- "D" style glass cutouts
- Self closing from approximately 25°
- Dual action - opens inwards and outwards
- Manufactured in solid brass
- Specially designed strong clamping plate with pre-glued EPDM gasket
- Enables hinging of door at 90°

Max door weight	35kg per pair
Max door width	800mm

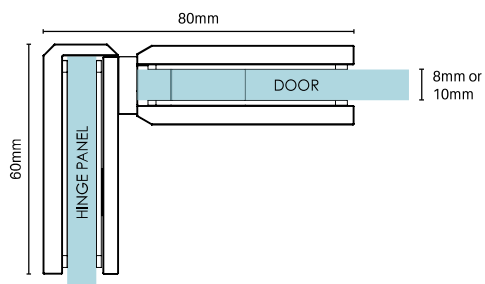

NERO

ZÜRICH HINGES

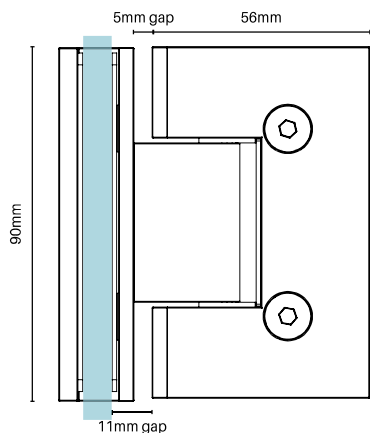

Zürich 90° glass to glass hinge

SQUARE EDGE

Chrome plated or pearl satin chrome finish

Order Code: ZUR-H-90 (Chrome)

ZUR-PEARL-H-90 (Pearl satin)

- Square finish edges
- Suitable for 8mm and 10mm glass
- "D" style glass cutouts
- Self closing from approximately 25°
- Dual action - opens inwards and outwards
- Brass centre block with solid precision clamping plates
- Special tempered SS304 square spring coil. Provides consistent long lasting opening and closing function
- Specially designed strong clamping plate with pre-glued EPDM gasket

Max door weight	35kg per pair
Max door width	800mm

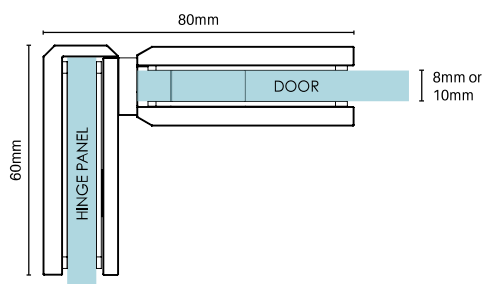

PEARL SATIN



CHROME



PURITY HINGES

Purity Showerscreens™ 135° glass to glass hinge

SQUARE EDGE

Chrome plated, matt black, brushed brass/gold, matt white, gunmetal & brushed nickel finish

Order Code: PB-H-135 (Bianco – Chrome)

PN-H-135 (Nero – Black)

P-ORO-H-135 (Oro – Brushed Brass/Gold)

P-SNO-H-135 (Sno – White)

P-GIO-H-135 (Gio – Gunmetal)

P-NIKL-H-135 (Nikl – Brushed Nickel)

- Square finish edges
- Suitable for 8mm and 10mm glass
- "D" style glass cutouts
- Self closing from approximately 25°
- Dual action - opens inwards and outwards
- Manufactured in solid brass
- Hinge panel glass requires 45° polished mitre edge on 1 x long edge
- Specially designed strong clamping plate with pre-glued EPDM gaskets

Max door weight 35kg per pair

Max door width 800mm

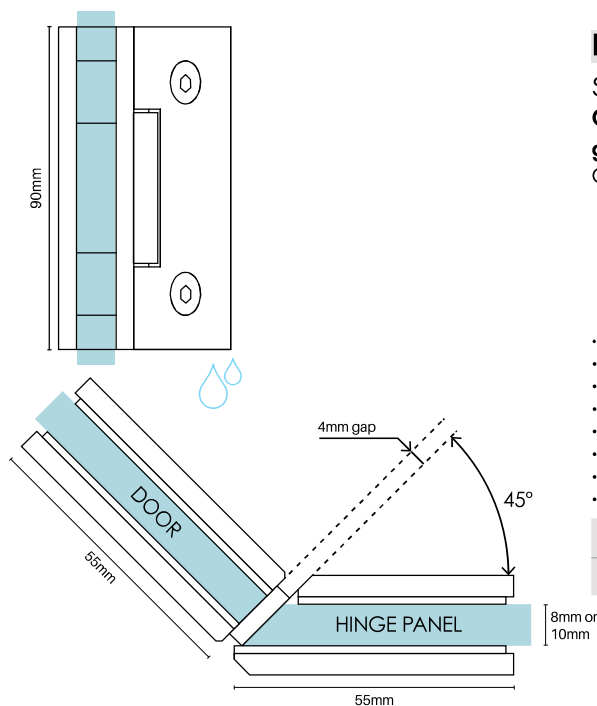

ZÜRICH HINGES

Zürich 135° glass to glass hinge

SQUARE EDGE

Chrome plated or pearl satin chrome finish

Order Code: ZUR-H-135 (Chrome)

ZUR-PEARL-H-135 (Pearl satin)

- Square finish edges
- Suitable for 8mm and 10mm glass
- "D" style glass cutouts
- Self closing from approximately 25°
- Dual action - opens inwards and outwards
- Brass centre block with solid precision clamping plates
- Special tempered SS304 square spring coil. Provides consistent long lasting opening and closing function
- Hinge panel glass requires 45° polished mitre edge on 1 x long edge
- Specially designed strong clamping plate with pre-glued EPDM gasket

Max door weight 35kg per pair

Max door width 800mm

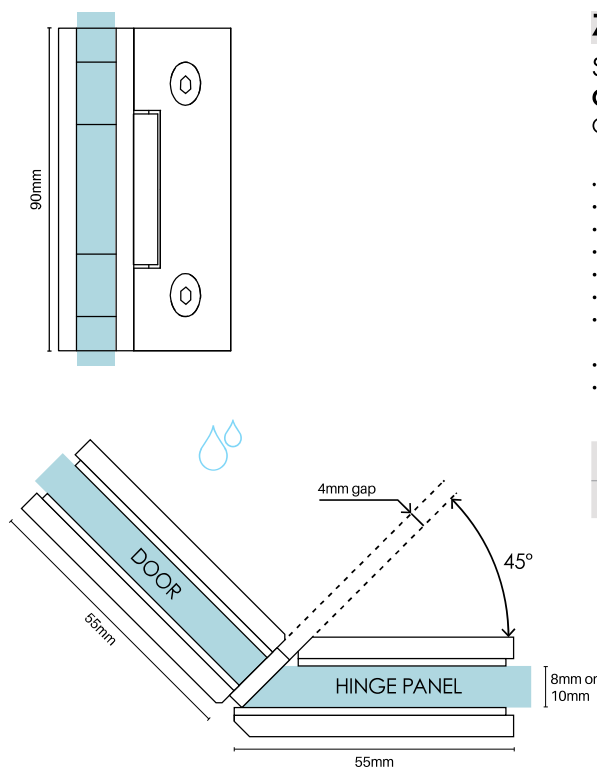



PURITY HINGES

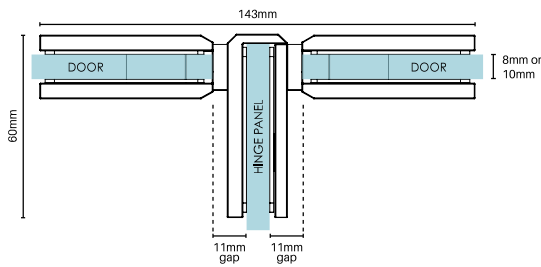
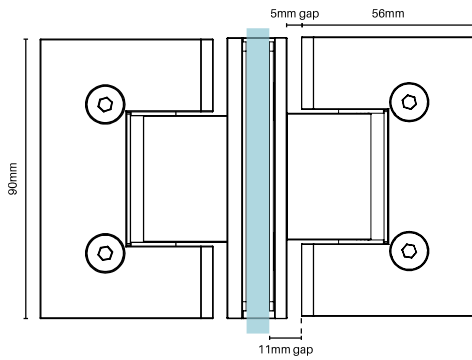

Purity Showercreens™ 3 way glass to glass hinge

SQUARE EDGE

Chrome plated or matt black finish

Order Code: PB-H-3W (Bianco – Chrome)

PN-H-3W (Nero – Black)

- Allows for hinging of 2 x doors from 1 x hinge panel
- Square finish edges
- Suitable for 8mm & 10mm glass
- "D" style glass cutouts
- Dual action - opens inwards & outwards
- Manufactured in solid brass
- Clamping plates pre-glued with EPDM gaskets for easy fitting

Max door weight 35kg per pair

Max door width 800mm



BIANCO



NERO





PURITY HEAVY DUTY HINGES

- Larger & thicker clamping plates & internal 5S304 spring
- Removeable pins provide optional use of 'mickey mouse' glass cut outs



Purity Showerscreens™ glass to glass hinge

HEAVY DUTY / SQUARE EDGE

Chrome plated or matt black

Order Code: PB-H-180-HD (Bianco – Chrome)

PN-H-180-HD (Nero – Black)

- Heavy duty hinges for larger doors
- Square finish edges
- Suitable for 8mm, 10 & 12mm glass
- "D" style glass cutouts OR 'mickey mouse' cutouts
- Includes screw-in pins for 'mickey mouse' – simply unscrew & remove for "D" cut outs
- Dual action – opens inwards & outwards
- Manufactured in solid brass
- Clamping plates pre-glued with EPDM gaskets for easy fitting

GLASS CUT OUT DETAIL

Cut out applies to heavy duty hinge styles

"D" CUTOUT

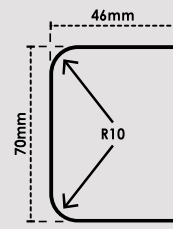

– OR –

MICKEY MOUSE CUTOUT

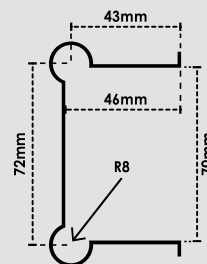

Hinge cannot be used with pre-made Purity stocked glass doors – cut out for glass is different for heavy duty hinges

Max door weight	50kg 2x hinges
	65kg 3x hinges
Max door width	915mm

HEAVY DUTY BIANCO / NERO

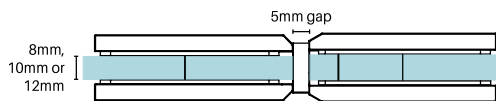
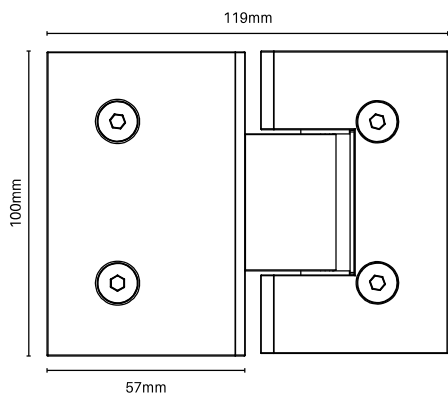

Purity Showerscreens™ wall to glass hinge

HEAVY DUTY / SQUARE EDGE

Chrome plated or matt black finish

Order Code: PB-H-WP-HD (Bianco – Chrome)

PN-H-WP-HD (Nero – Black)

- Heavy duty wall hinges for larger doors
- 4 x fixing holes
- Square finish edges
- Suitable for 8mm, 10 & 12mm glass
- "D" style glass cutouts OR "mickey mouse" cutouts
- Includes screw-in rods for "mickey mouse" – simply unscrew & remove for "D" cut outs
- Dual action – opens inwards & outwards
- Manufactured in solid brass

SEE CUT OUT DETAILS FOR HEAVY DUTY HINGES ABOVE

Hinge cannot be used with pre-made Purity stocked glass doors – cut out for glass is different for heavy duty hinges

Max door weight	50kg 2x hinges
	65kg 3x hinges
Max door width	915mm

HEAVY DUTY BIANCO / NERO

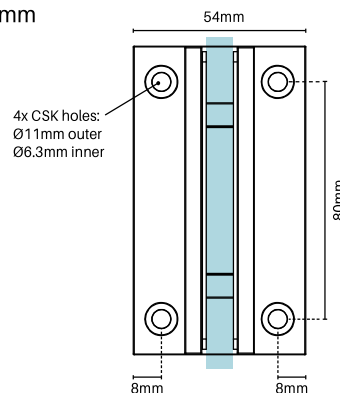
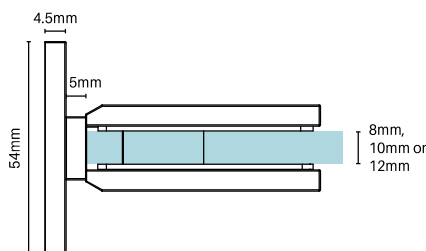
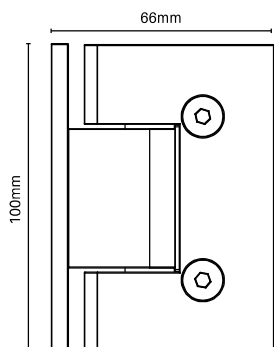



ZÜRICH HINGES SUITS 6MM GLASS



Zürich 6mm glass to glass hinge

SQUARE EDGE

Chrome plated or matt black finish

Order Code: ZUR-H-180-6MM (Chrome)

ZUR-H-180-6MM-BLK (Black)

- Square finish edges with radius corners
- Suitable for 6mm & 8mm glass
- Specially designed strong clamping plates with pre-glued EPDM gaskets
- Self closing from approximately 25°
- Dual action - opens inwards & outwards
- Allen key & screw cover caps included

Max door weight 30kg per pair

Max door width 800mm

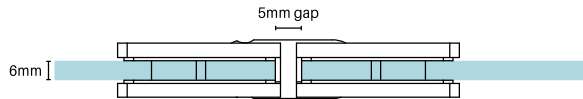
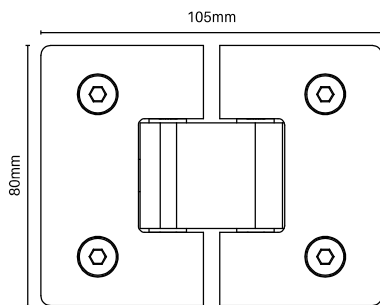

GLASS CUT OUT DETAIL

This cut out applies to Zürich 6mm hinges

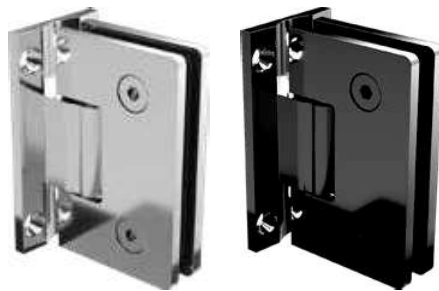
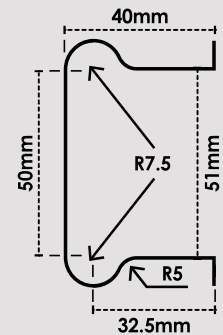

Zürich 6mm wall to glass hinge

SQUARE EDGE

Chrome plated or matt black finish

Order Code: ZUR-H-WP-6MM (Chrome)

ZUR-H-WP-6MM-BLK (Black)

- Square finish edges with radius corners
- Suitable for 6mm & 8mm glass
- Specially designed strong clamping plates with pre-glued EPDM gaskets
- Self closing from approximately 25°
- Dual action - opens inwards & outwards
- 4x SS304 fixing screws with wall plugs, allen key & screw cover caps included

Max door weight 30kg per pair

Max door width 800mm

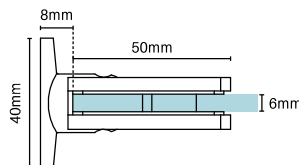
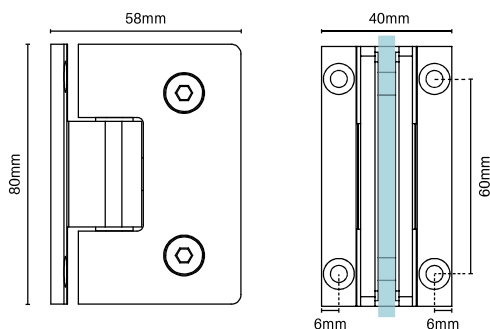



WALL BRACKETS

Suits 8mm & 10mm glass panels

1

2mm rear wall thickness

Thin back wall to minimise gap between wall and glass panel

2

Interior packers

Moulded plastic packer fits to interior back and side walls to prevent glass from touching metal

3

Countersunk internal back hole

Flush screw fixing with countersunk hole (1x wall screw with plug included in box)

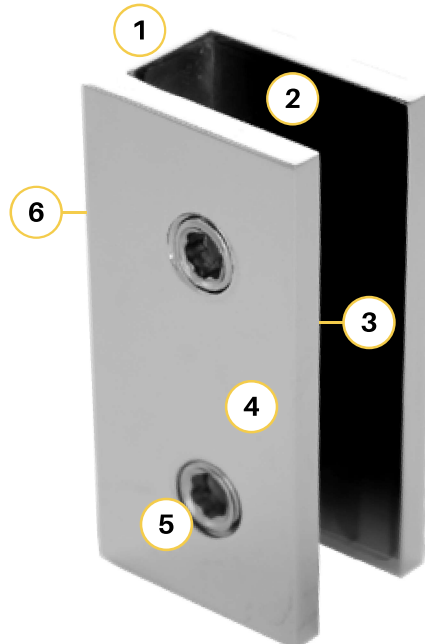
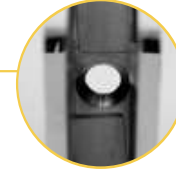

4

Superior manufactured finish

Superior blemish free
Available in a range of finishes

5

Allen key head screws

2x hex head screws for secure friction fitting to glass panel. Internal screw heads are flat with plastic capping

6

Clear PVC back packer

Thin clear PVC affixed to back of bracket to minimise issues when installing to a tiled surface





PURITY GLASS BRACKETS

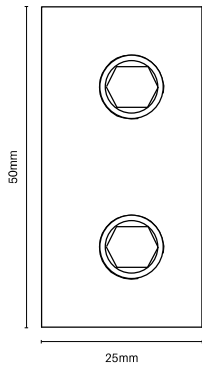

Purity Showerscreens™ wall bracket

SQUARE EDGE

Chrome plated, matt black, brushed brass/gold, matt white, gunmetal, brushed nickel & pearl satin finish

Order Code: P-WB (Bianco – Chrome)

PN-WB (Nero – Black)

P-ORO-WB (Oro – Brushed Brass/Gold)

P-SNO-WB (Sno – White)

P-GIO-WB (Gio – Gunmetal)

P-NIKL-WB (Nikl – Brushed Nickel)

P-PEARL-WB (Pearl satin)

- Wall bracket - concealed central countersunk fixing
- Suitable for 8mm & 10mm glass
- 2x compression/friction screws - quick and flexible installation as no holes in glass required
- Slimline 2mm rear wall reduces silicone gap between wall and glass panel
- 1x fixing screw & wall plug provided

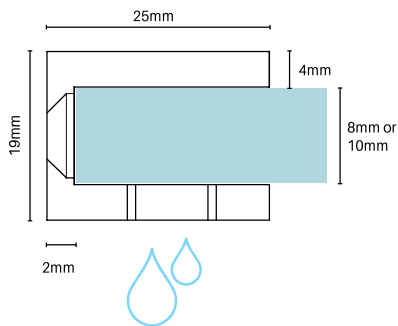

BIANCO

NERO

ORO

SNO

GIO

NIKL

PEARL
SATIN

*Silicone must be used along glass edges when friction brackets used

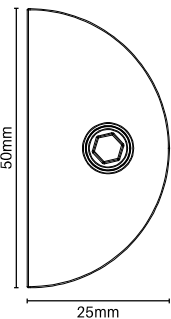

Purity Showerscreens™ round wall bracket

Chrome plated or matt black finish

Order Code: P-WB-RND (Bianco – Chrome)

PN-WB-RND (Nero – Black)

- Stylish wall bracket with concealed countersunk fixing
- Slimline half round profile
- Suitable for 8mm and 10mm glass - no holes in glass required
- Slimline 2.5mm rear wall thickness reduces silicone gap
- 1x screw & wall plug provided

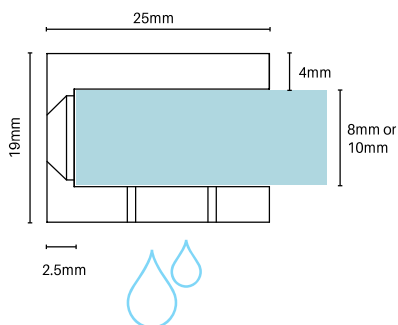

BIANCO

NERO

*Silicone must be used along glass edges when friction brackets used



PURITY GLASS BRACKETS

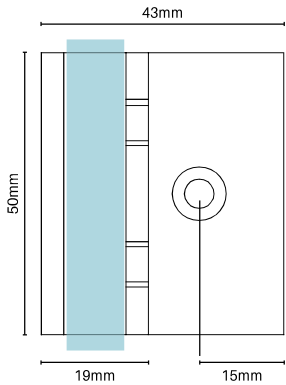

Purity Showerscreens™ offset wall bracket

SQUARE EDGE

Chrome plated, matt black, brushed brass/gold, matt white, gunmetal, brushed nickel & pearl satin finish

Order Code: P-WB-O (Bianco – Chrome)

PN-WB-O (Nero – Black)

P-ORO-WB-O (Oro – Brushed Brass/Gold)

P-SNO-WB-O (Sno – White)

P-GIO-WB-O (Gio – Gunmetal)

P-NIKL-WB-O (Nikl – Brushed Nickel)

P-PEARL-WB-O (Pearl satin)

- Wall bracket - with offset leg
- Suitable for 8mm & 10mm glass
- 2x compression/friction screws - quick and flexible installation as no holes in glass required
- Offset leg is useful when affixing glass close to corner by positioning fixing screw away from wall edge
- 1x fixing screw & wall plug provided

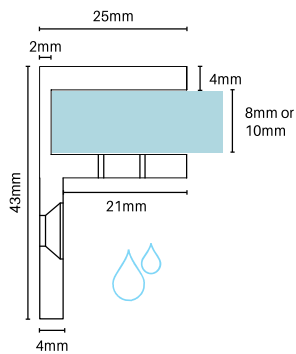

BIANCO

NERO

ORO

SNO

GIO

NIKL

PEARL SATIN

*Silicone must be used along glass edges when friction brackets used

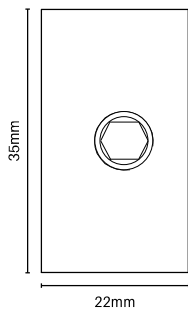

Purity Showerscreens™

6mm wall bracket

Chrome plated – Square edge

Order Code: P-WB-6MM (Bianco – Chrome)

- Wall bracket to suit 6mm thick toughened glass
- Single concealed countersunk fixing to wall
- 1 x compression/friction screw - quick and flexible install. No holes in glass required
- Slimline 2.4mm rear wall reduces silicone gap between wall and glass panel

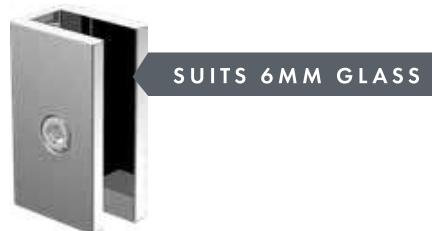
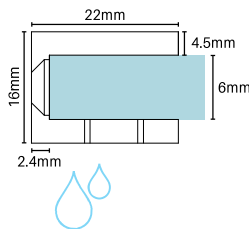

BIANCO

*Silicone must be used along glass edges when friction brackets used



MECHANICALLY FIXED GLASS BRACKETS

Ideal for large shower panels



BIANCO NERO

Purity square wall bracket

Chrome plated or matt black finish

Order Code: P-MECH-WB (Bianco – Chrome)
PN-MECH-WB (Nero – Black)

- Mechanical fixing of glass to wall
- Hidden single fixing to wall (SS304 wall fixing screw included)
- Suitable for 6mm, 8mm & 10mm glass

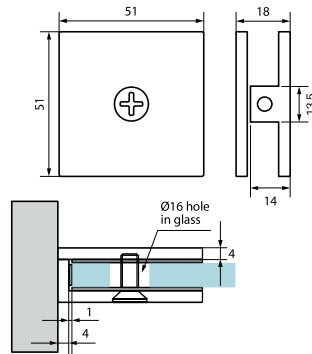

Glass may be made with cut out around rear wall 13.5mm plate to reduce gap between wall and glass panel

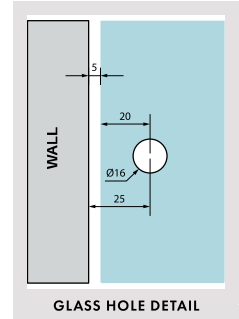

GLASS HOLE DETAIL



BIANCO NERO ORO

Purity square offset wall bracket

Chrome plated, matt black or brushed brass/gold finish

Order Code: P-MECH-WB-O (Bianco – Chrome)
PN-MECH-WB-O (Nero – Black)
P-ORO-MECH-WB-O (Oro – Brushed Brass/Gold)

- Mechanical fixing of glass to wall
- L plate offsets wall fixing (SS304 wall fixing screw included)
- Useful when fitting glass close to a corner
- Suitable for 6mm, 8mm & 10mm glass

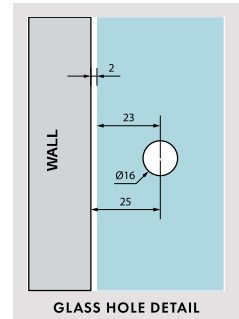
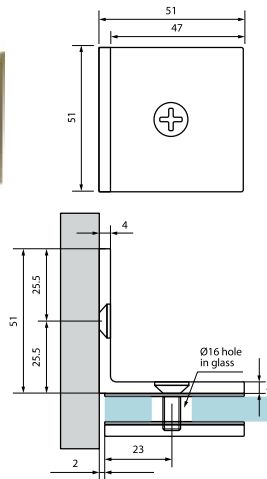

GLASS HOLE DETAIL



BIANCO NERO SNO GIO NIKL ORO PEARL SATIN

SLIMLINE LEG

Purity square slimline offset wall bracket

Chrome plated, matt black, matt white, gunmetal, brushed nickel & brushed brass/gold finish

Order Code: P-MECH-WB-SLO (Bianco – Chrome)
PN-MECH-WB-SLO (Nero – Black)
P-SNO-MECH-WB-SLO (Sno – White)
P-GIO-MECH-WB-SLO (Gio – Gunmetal)
P-NIKL-MECH-WB-SLO (Nikl – Brushed Nickel)
P-ORO-MECH-WB-SLO (Oro – Brushed Brass/Gold)
P-PEARL-MECH-WB-SLO (Pearl satin)

- Mechanical fixing of glass to wall
- Slimline L offset wall fixing (SS304 wall fix screw included)
- Slimline leg provides a neat, unobtrusive finish
- Useful when fitting glass close to a corner
- Suitable for 6mm, 8mm & 10mm glass

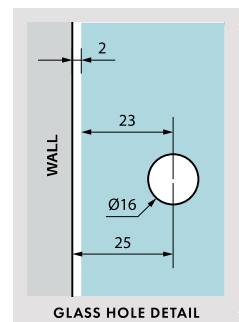
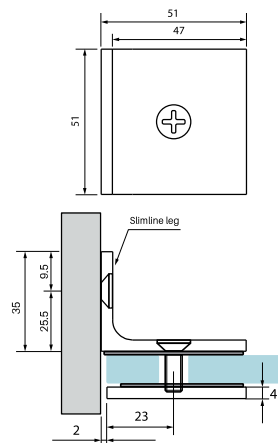

GLASS HOLE DETAIL



MECHANICALLY FIXED GLASS BRACKETS

Ideal for large shower panels



BIANCO



NERO

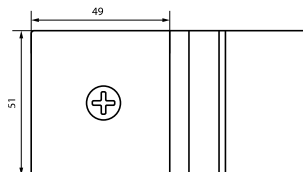

Glass configuration

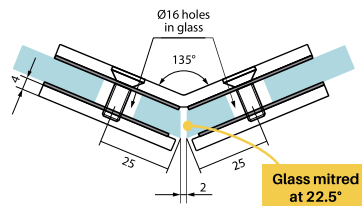

Purity square 135° bracket

Chrome plated or matt black finish

Order Code: P-MECH-GGB-135 (Bianco – Chrome)

PN-MECH-GGB-135 (Nero – Black)

- Mechanical fixing of glass panels at 135°
- Glass must be mitred at 22.5°
- Suitable for 6mm, 8mm & 10mm glass



BIANCO



NERO

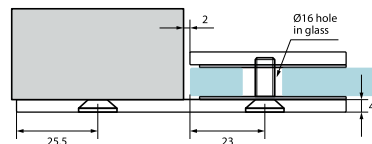
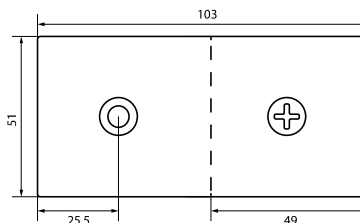

Purity square inline offset wall bracket

Chrome plated or matt black finish

Order Code: P-MECH-WB-IO (Bianco – Chrome)

PN-MECH-WB-IO (Nero – Black)

- Mechanical fixing of glass panels to inline wall configuration
- Easy fixing into wall (SS304 wall fixing screw included)
- Suitable for 6mm, 8mm & 10mm glass



BIANCO



NERO

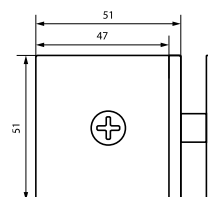

Glass configuration option 1

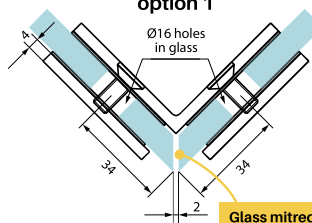

Glass configuration option 2

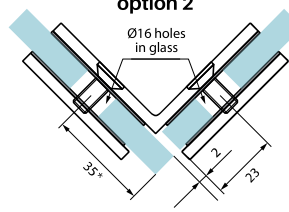

*This size is used when 8mm thick glass is selected

Purity square 90° bracket

Chrome plated or matt black finish

Order Code: P-MECH-GGB-90 (Bianco – Chrome)

PN-MECH-GGB-90 (Nero – Black)

- Mechanical fixing of glass panels at 90°
- Two glass configurations possible
- Suitable for 6mm, 8mm & 10mm glass



PURITY KNOBS

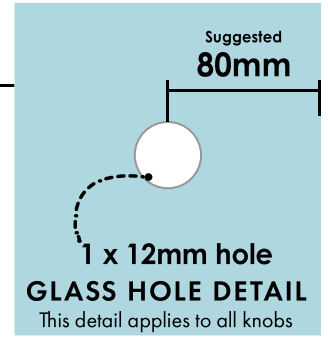

Purity Showerscreens™ Round circular knob

Chrome plated, matt black, brushed brass/gold, matt white, gunmetal & brushed nickel finishes

- Order Code: P-KRC (Bianco – Chrome)
 PN-KRC (Nero – Black)
 P-ORO-KRC (Oro – Brushed Brass/Gold)
 P-SNO-KRC (Sno – White)
 P-GIO-KRC (Gio – Gunmetal)
 P-NIKL-KRC (Nikl – Brushed Nickel)
 P-PEARL-KRC (Pearl satin)

- Solid round knob with two circular grooves
- Slimline Ø25mm double pull knob
- Suits 6mm, 8mm, 10mm and 12mm thick glass
- 30mm long per side

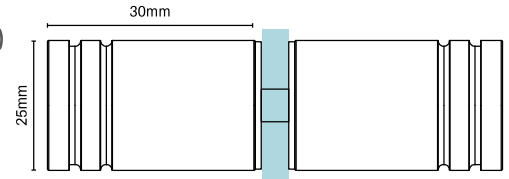

Purity Showerscreens™ Full round knob

Chrome plated or matt black finish

- Order Code: P-KRF (Bianco – Chrome)
 PN-KRF (Nero – Black)

- Sleek solid round knob with finger notch
- Double pull knob
- Suits 8mm, 10mm and 12mm thick glass

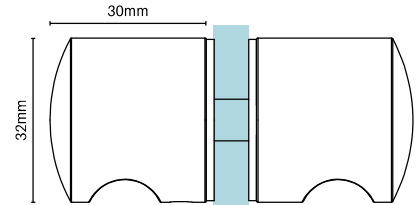

Purity Showerscreens™ Round recessed knob

Chrome plated or matt black finish

- Order Code: P-KRR (Bianco – Chrome)
 PN-KRR (Nero – Black)

- Easy gripping with full finger notch
- Double pull knob
- Suits 8mm, 10mm and 12mm thick glass

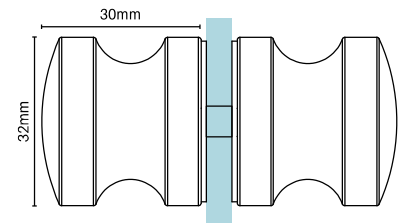

Purity Showerscreens™ Square recessed knob

Chrome plated or matt black finish

- Order Code: P-KSR (Bianco – Chrome)
 PN-KSR (Nero – Black)

- Easy gripping with full finger notch
- Double pull knob
- Suits 8mm, 10mm and 12mm thick glass

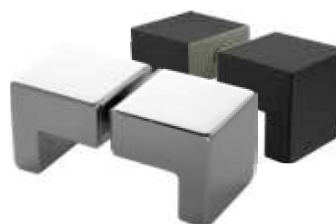
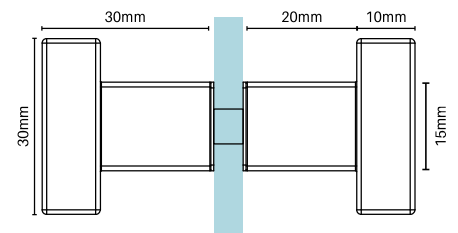

Purity Showerscreens™ Square L shape knob

Chrome plated or matt black finish

- Order Code: P-KSL (Bianco – Chrome)
 PN-KSL (Nero – Black)

- L shape profile
- Double pull knob
- Suits 8mm, 10mm and 12mm thick glass

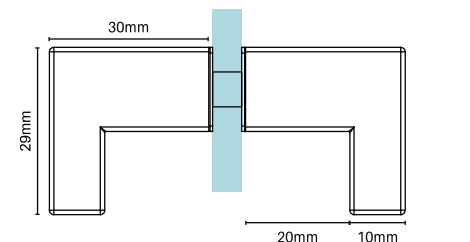



ZÜRICH KNOBS



Zürich round circular knob

Chrome plated or pearl satin finish

Order Code: ZUR-KRC (Chrome)
ZUR-PEARL-KRC (Pearl satin)

- Slimline Ø25mm round knob with two circular grooves
- Double pull knob
- Suits 6mm, 8mm, 10mm and 12mm thick glass
- Polish or pearl satin chrome
- 40mm long per side
- Outstanding price point

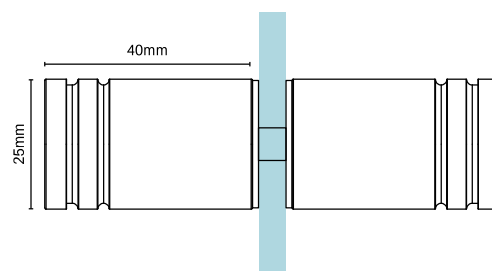

Zürich full round knob

Chrome plated or pearl satin finish

Order Code: ZUR-KRF (Chrome)
ZUR-PEARL-KRF (Pearl satin)

- Sleek round knob with finger notch
- Double pull knob
- Suits 8mm, 10mm and 12mm thick glass
- Polish or pearl satin chrome
- Outstanding price point

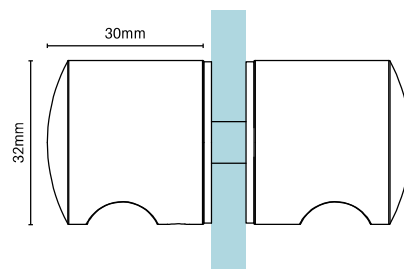

Zürich square recessed knob

Chrome plated or pearl satin finish

Order Code: ZUR-KSF (Chrome)
ZUR-PEARL-KSF (Pearl satin)

- Easy gripping with full finger notch
- Double pull knob
- Suits 8mm, 10mm and 12mm thick glass
- Polish or pearl satin chrome
- Outstanding price point

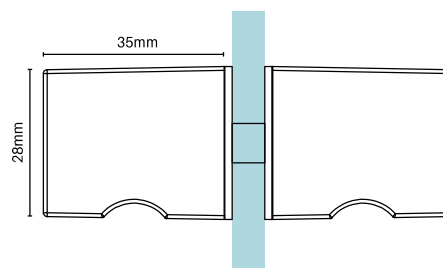

SOLID ALLOY KNOBS



Purity Showerscreens™

Solid premium alloy round circular knob

Matt black

Order Code: PN-KRC-AA (Nero – Black)

- Round knob with two circular grooves
- Slimline Ø25mm double pull knob
- Suits 6mm, 8mm, 10mm and 12mm thick glass
- Premium alloy with precision CNC machining
- Superior corrosion resistance

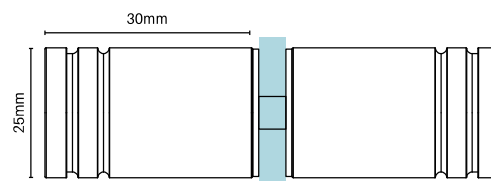

Purity Showerscreens™

Solid premium alloy round recessed knob

Matt black

Order Code: PN-KRR-AA (Nero – Black)

- Easy gripping with full finger notch
- Double pull knob
- Suits 8mm, 10mm and 12mm thick glass
- Premium alloy with precision CNC machining
- Superior corrosion resistance

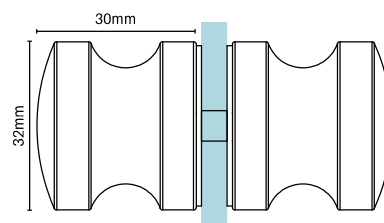



PURITY HANDLES

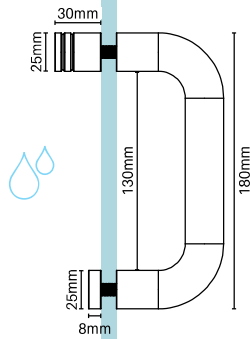

Purity Showerscreens™ round D handle with internal knob

Polish SS304 – 180mm long

Order Code: P-HANDLE-180 (180mm long)

- Pull knob on inside of door panel with external D handle; Ø25mm
- Suits 8mm, 10mm and 12mm glass
- Manufactured in SS304; Polish finish
- Nylon spacers and gaskets included to prevent glass touching metal
- 180mm handle suits holes in modular Purity doors

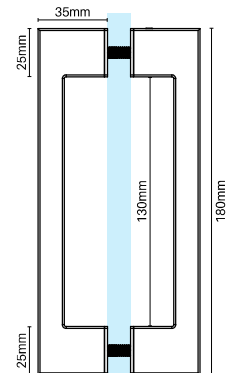
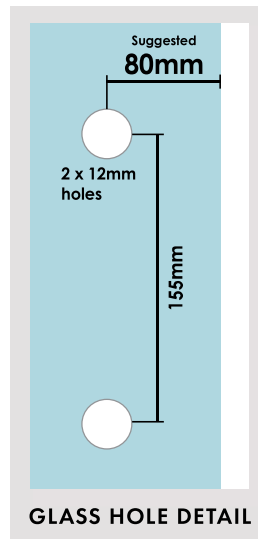

Purity Showerscreens™ Square D handle

Polish SS304 or matt black finish

Order Code: P-HD (Bianco – Chrome)
PN-HD (Nero – Black)

- Back to back pull handle; suits 8mm, 10mm and 12mm glass
- Manufactured in SS304; Polish or matt black finish
- Nylon spacers and gaskets included to prevent glass touching metal
- Suits holes in modular purity doors

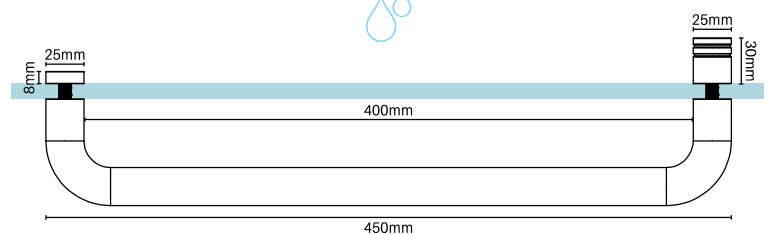

Purity Showerscreens™ 450mm round D handle with internal knob

Polish SS304 – 450mm long

Order Code: P-HANDLE-450 (450mm long)

- Pull knob on inside of door panel with external D handle; Ø25mm
- Suits 8mm, 10mm and 12mm glass
- Manufactured in SS304; Polish finish
- Nylon spacers and gaskets included to prevent glass touching metal
- 450mm handle commonly installed horizontally with external D handle to be used as a towel rail – suits 425mm hole to hole centres
- May also be installed vertically (with holes in glass as required)
- Does not suit installation with modular glass door panels. Custom made glass is required

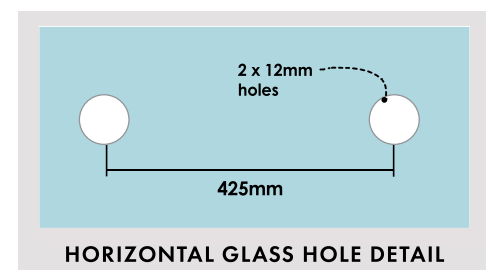



ZÜRICH HANDLES

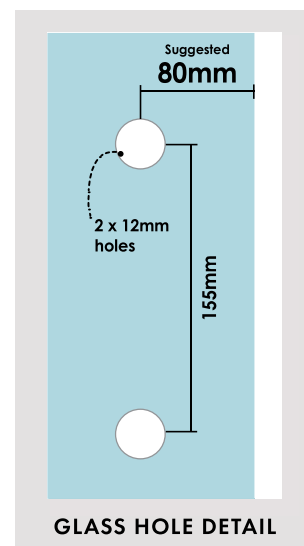
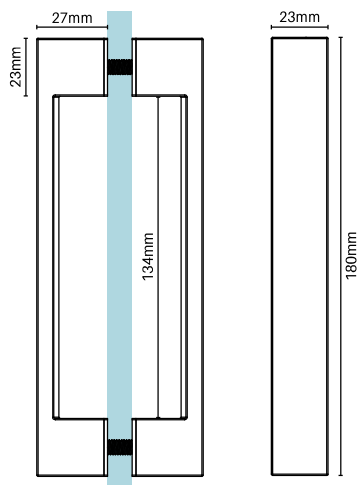

Zürich Square D handle – 180mm long

Chrome plated or pearl satin finish

Order Code: ZUR-HD (Chrome)

ZUR-PEARL-HD (Pearl satin)

- Latest European design with slimline square profile with inner rounded handle for easy gripping
- Back to back pull handle; suits 8mm, 10mm and 12mm glass
- Polish or pearl satin chrome finish
- Nylon spacers and gaskets included to prevent glass touching metal
- Suits holes in modular Purity doors

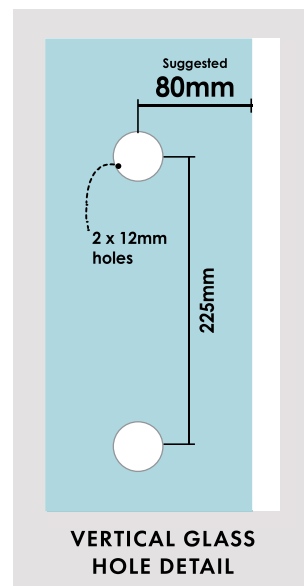
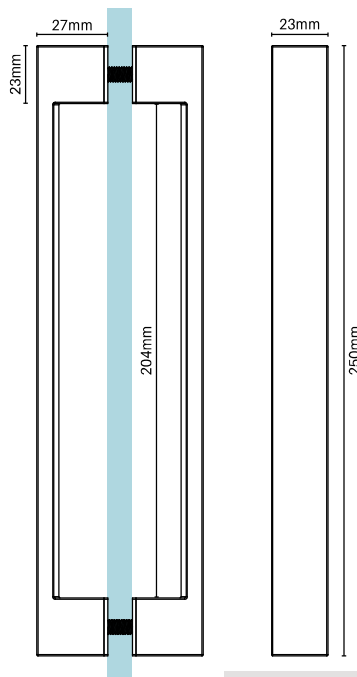

Zürich Square D handle – 250mm long

Chrome plated or pearl satin finish

Order Code: ZUR-HD-250 (Chrome)

ZUR-PEARL-HD-250 (Pearl satin)

- Latest European design with slimline square profile with inner rounded handle for easy gripping
- Back to back pull handle; suits 8mm, 10mm and 12mm glass
- Polish or pearl satin chrome
- Nylon spacers and gaskets included to prevent glass touching metal
- Install vertically or horizontally - horizontal rail may be used as a towel rail
- Does not suit installation with modular glass door panels. Custom made glass is required

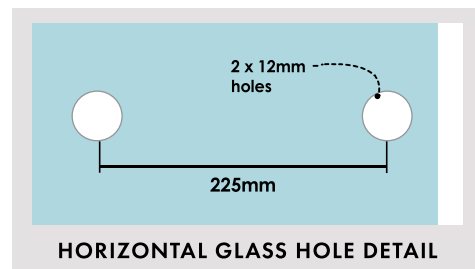



PURITY GLASS BRACKETS

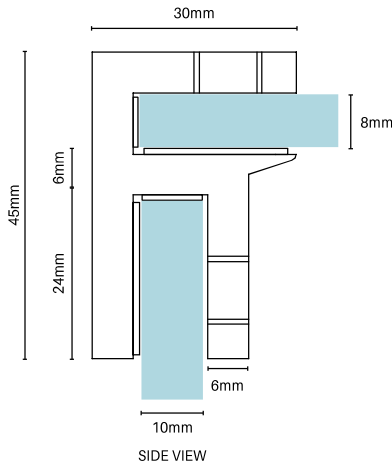

Purity Showerscreens™ glass brace bracket

SMALL – SQUARE EDGE

Chrome plated, matt black, brushed brass/gold, matt white, gunmetal, brushed nickel & pearl satin finishes

Order Code: P-GBB-S (Bianco – Chrome)

PN-GBB-S (Nero – Black)

P-ORO-GBB-S (Oro – Brushed Brass/Gold)

P-SNO-GBB-S (Sno – White)

P-GIO-GBB-S (Gio – Gunmetal)

P-NIKL-GBB-S (Nikl – Brushed Nickel)

P-PEARL-GBB-S (Pearl satin)

- Brace 8mm thick glass hood to 10mm thick hinge and return panel for stability
- Removes requirement for silicone use
- 2x compression/friction screws – quick and flexible installation as no holes in glass required
- Manufactured in solid brass

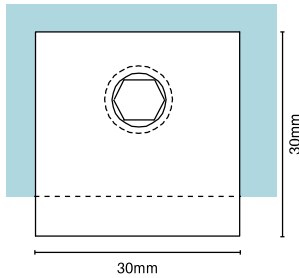

Place bracket ensuring glass door does not hit when swinging inwards

Eliminate the need for silicone with the friction fit glass brace panel brackets – Glass brace hood panel stabilises hinge and return panels



PURITY GLASS BRACKETS & DOOR STOPS

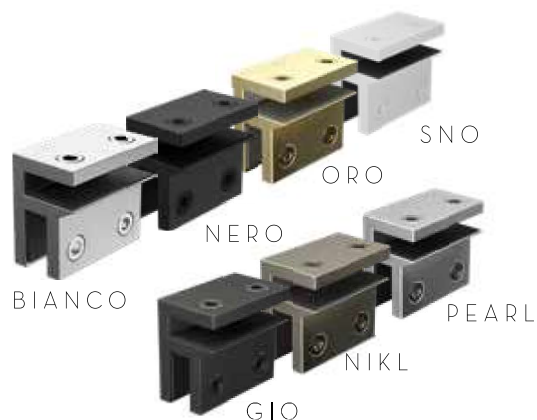

Purity Showerscreens™ glass brace bracket

LARGE – SQUARE EDGE

Chrome plated, matt black, brushed brass/gold, matt white, gunmetal, brushed nickel & pearl satin finishes

Order Code: P-GBB-L (Bianco – Chrome)

PN-GBB-L (Nero – Black)

P-ORO-GBB-L (Oro Brushed Brass/Gold)

P-SNO-GBB-L (Sno – White)

P-GIO-GBB-L (Gio – Gunmetal)

P-NIKL-GBB-L (Nikl – Brushed Nickel)

P-PEARL-GBB-L (Pearl satin)

- Brace 8mm thick glass hood to 10mm thick hinge and return panel for stability
- Removes requirement for silicone use
- 4x compression/friction screws – quick and flexible installation as no holes in glass required
- Manufactured in solid brass
- Double screw sturdy design

Place bracket ensuring glass door does not hit when swinging inwards

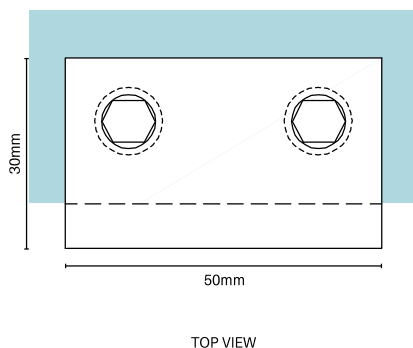
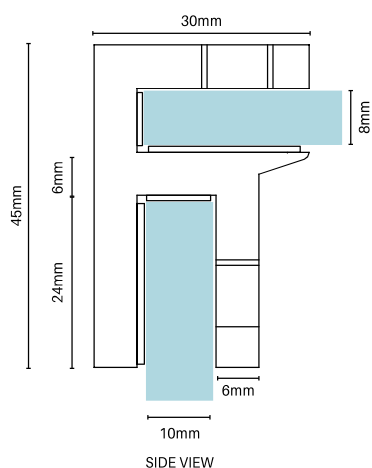

Eliminate the need for silicone with the friction fit glass brace panel brackets – Glass brace hood panel stabilises hinge and return panels



BIANCO



PEARL SATIN

Purity Showerscreens™ door stop

Polish SS304 or pearl satin finish

Order Code: P-STOP (Bianco – Chrome)

P-PEARL-STOP (Pearl satin)

- Slimline door stop
- Includes a non-removable rubber insert to prevent glass touching metal
- Special stainless steel leg attached to the base for added strength and to prevent the door stop from pivoting – leg is removable if required
- Manufactured from SS304 in polish or pearl satin
- Includes fixing screw with plug

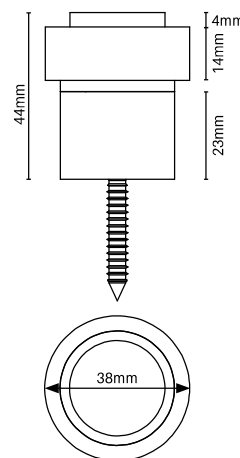
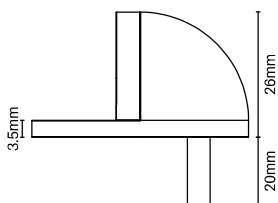
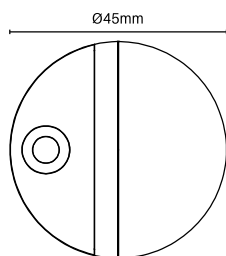

Purity Showerscreens™ door bump stop

Satin finish – SS304

Order Code: P-BUMP-S

- Versatile door stopper – install into floor (vertically) or into wall (horizontally)
- 2 part design enables easy installation plus hidden fixing
- Single sturdy ST8x65mm SS304 screw
- Side rubber position can be changed to line up with glass





PURITY SUPPORT ARMS



Purity Showerscreens™ adjustable arm bracket

SMALL ARM BRACKET

Chrome plated, matt black, brushed brass/gold, matt white, gunmetal, brushed nickel & pearl satin finishes

- Order Code: P-ARM-A (Bianco – Chrome)
 PN-ARM-A (Nero – Black)
 P-ORO-ARM-A (Oro Brushed Brass/Gold)
 P-SNO-ARM-A (Sno – White)
 P-GIO-ARM-A (Gio – Gunmetal)
 P-NIKL-ARM-A (Nikl – Brushed Nickel)
 P-PEARL-ARM-A (Pearl Satin)

- Slimline wall to glass support arm for stabilising single glass panels
- Brace from wall to glass panel at a 45° angle to provide rigidity
- Double adjustability for easy installation; can swivel at both ends
- Unique hidden fixing wall installation for a neat finish
- Suitable for 8mm & 10mm glass
- Compression/friction screws – quick and flexible installation as no holes in glass required
- Manufactured in solid brass with SS304 tube

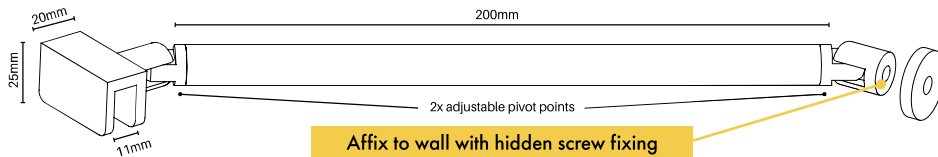

Easy angle adjustment!

Angle is easily adjustable from both ends of bracket

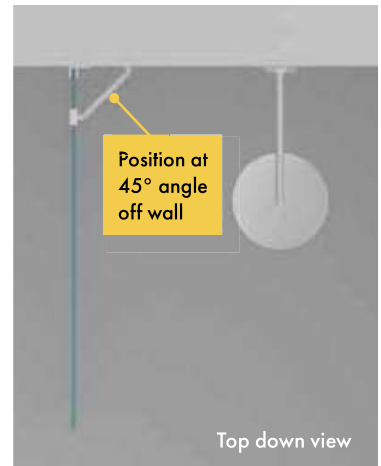

Purity Showerscreens™ round horizontal support arm

Chrome plated, matt black, brushed brass/gold, matt white, gunmetal, brushed nickel & pearl satin finishes

- Order Code: P-ARM-1200 (Bianco – Chrome)
 P-ORO-ARM-1200 (Oro – Brushed Brass/Gold)
 P-SNO-ARM-1200 (Sno – White)
 P-GIO-ARM-1200 (Gio – Gunmetal)
 P-NIKL-ARM-1200 (Nikl – Brushed Nickel)
 P-PEARL-ARM-1200 (Pearl satin)

- Fix horizontally from wall to top of glass panel
- Easy horizontal fixing solution for stabilising single glass panels
- Horizontal fixing – hidden fixing into wall (internal CSK screw)
- Width adjustable up to 1200mm – simply cut stainless tube to required length
- Suitable for 8mm & 10mm glass
- Friction fit to glass panel (no hole in glass required)
- Manufactured in solid brass with SS304 tube

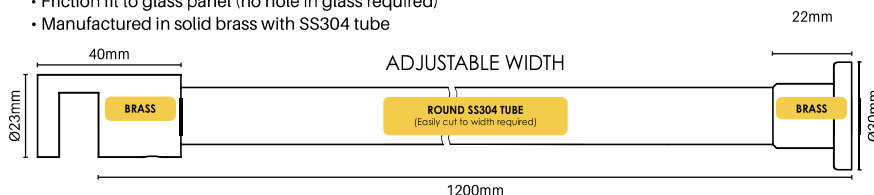

Easy width adjustment!

Simply cut to desired length and reattach fitting with grub screws

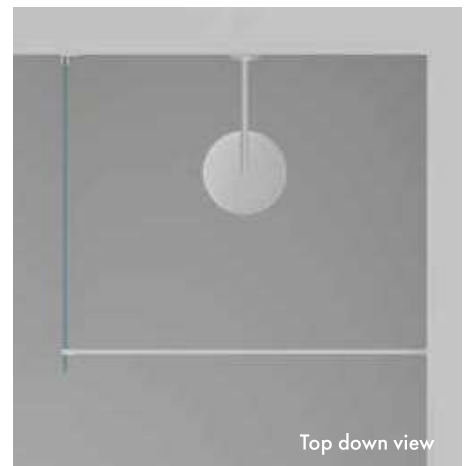



PURITY SUPPORT ARMS



Easy width adjustment!

Simply cut to desired length and reattach fitting with grub screws

Purity Showerscreens™ square horizontal support arm

Brass & square SS304 tube

Order Code: P-ARM-1200-SQ (Bianco – Chrome)

PN-ARM-1200-SQ (Nero – Black)

- Fix horizontally from wall to top of glass panel
- Popular square design
- Easy horizontal fixing solution for stabilising single glass panels
- Horizontal fixing – hidden fixing into wall (internal CSK screw)
- Width adjustable up to 1200mm – simply cut stainless tube to required length
- Suitable for 8mm & 10mm glass
- Friction fit to glass panel (no hole in glass required)
- Manufactured in solid brass with SS304 tube

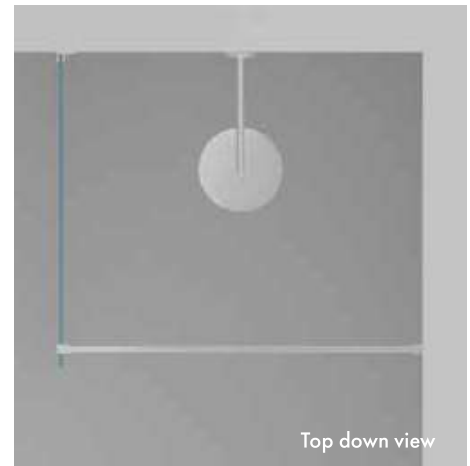
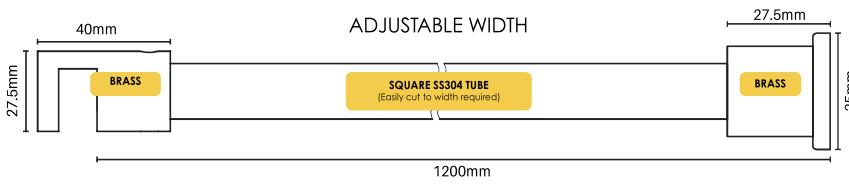

Top down view



Purity Showerscreens™ vertical stabiliser arm

Chrome plated brass & SS304 tube

Order Code: P-ARM-ST (Bianco – Chrome)

- Solution for stabilising glass panel from a ceiling
- Unique hidden ceiling fixing (internal CSK screw) for a neat finish
- Suitable for 8mm & 10mm glass
- Adjustable length – simply cut stainless tube to required length
- Friction fit to glass panel (no hole in glass required)
- Manufactured in solid brass with SS304 tube

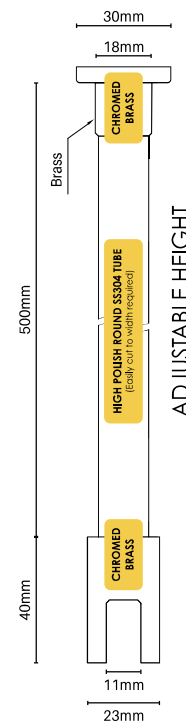

Easy height adjustment!

Simply cut to desired height and reattach fitting with grub screws



Side view



L ANGLE BRACE



Purity 'L Brace' for fixed glass panels

Suits 8mm & 10mm thick glass

Polish or satin finish

- New design brace for fixed panels
- Made from SS304 in polish or satin finish
- No holes in glass required
- Neatly sits on top of glass panel
- Fix off to wall via offset leg
- All fixings are hidden

Purity L Brace – Left

Polish or satin finish

Order Code: P-LBRACE-P-L (Polish)
P-LBRACE-S-L (Satin)



Purity L Brace – Right

Polish or satin finish

Order Code: P-LBRACE-P-R (Polish)
P-LBRACE-S-R (Satin)

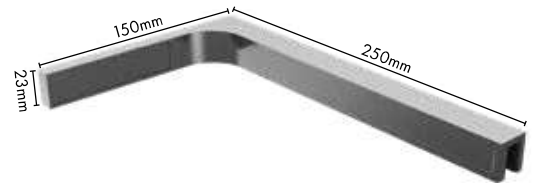

A right 'L Brace' needs to be installed on the right-hand side of the shower as you walk in, and a left 'L Brace' needs to be installed on the left-hand side of the shower as you walk in.

TOP VIEW

RIGHT 'L Brace'

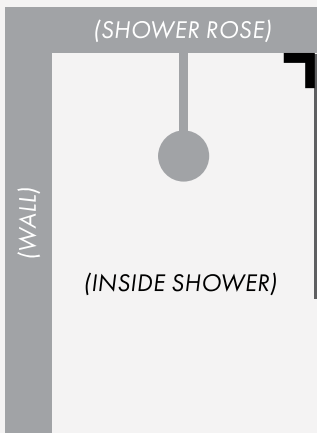

TOP VIEW

LEFT 'L Brace'





L ANGLE BRACE



HOW TO INSTALL



STEP 1

Install glass fixed panel



STEP 2

Position brace onto glass panel and secure using friction screws. Mark fixing position to wall and then remove brace. Pilot hole drill for fixings (and wall plugs if required)



STEP 3

Replace brace, affix to wall and then secure to glass panel with 2 x friction screws



STEP 4

Install 2 x cover plates to hide fixings



BLITZ GLASS

Showers

Accessories



www.blitzglass.com.au



(07) 5493 9779



admin@blitzglass.com.au



SHOWER ACCESSORIES

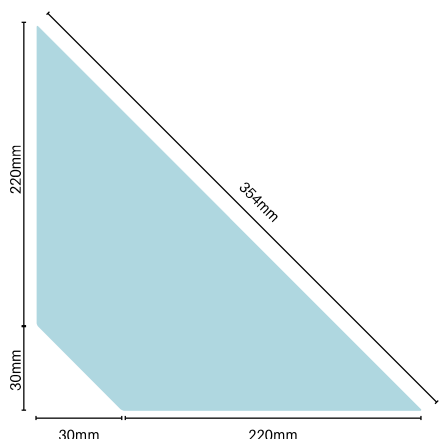

Purity Showerscreens™ glass shelf

Order Code: P-S-0250

- Handy and stylish shelf for storage of bottles/soap in shower
- Can also be used as a brace for rigidity of glass panels

8mm thick clear toughened

1 mm radius corners

Individually boxed panels

Flat polished edges

Corner protectors in packing

Thickness	Sqm	Weight
8mm	0.06	1.3kg

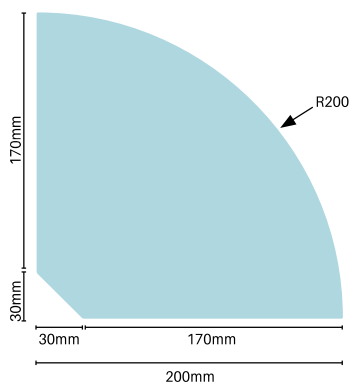

Purity Showerscreens™ glass shelf with radius

Order Code: P-S-R200

- Handy and stylish shelf for storage of bottles/soap in shower
- Can also be used as a brace for rigidity of glass panels
- Stylish 200mm radius shape

10mm thick clear toughened

Radius 200mm

Individually boxed

Flat polished edges

Thickness	Sqm	Weight
10mm	0.04	0.8kg

Enduroshield glass treatment kit

Order Code: ENDURO-GC-125

- Covers up to 8sqm
- Water and oil repellent
- 1 application lasts 3+ years
- Kit includes pre-cleaner product and surface treatment
- Cuts cleaning time by up to 90%
- DIY kit commonly used & applied to glass by home owner

Kit includes:

- 125m Enduroshield Glass Home
- Surface treatment
- 250mL EnduroClean Pre-Cleaner
- Fine steel wool
- Polishing cloth
- Step by step instructions
- 3 year limited warranty

**ALSO AVAILABLE IN
500ML BOTTLES**

Covers up to 32sqm

Order Code: ENDURO-GC-500





U CHANNELS

Purity Showerscreens™

Aluminium U channel

Chrome plated, matt black, brushed brass/gold, matt white, gunmetal, brushed nickel & pearl satin finishes

Order Code: P-U-2100 (Bianco – Polish)

PN-U-2100 (Nero – Black)

P-ORO-U-2100 (Oro Brushed Brass/Gold)

P-SNO-U-2100 (Sno – White)

P-GIO-U-2100 (Gio – Gunmetal)

P-NIKL-U-2100 (Nikl – Brushed Nickel)

P-PEARL-U-2100 (Pearl satin)

- Slimline dry glaze system - no need for silicone on glass
- Fast installation
- Suitable for 10mm clear glass
- Consider using when wall is out of square (up to 6mm)
- Internal ribs hold secure 2 part clear glazing PVC
- U channel and 2 part clear glazing PVC included
- 2100mm long - easy to cut shorter if required
- Positions glass edge 10mm from wall

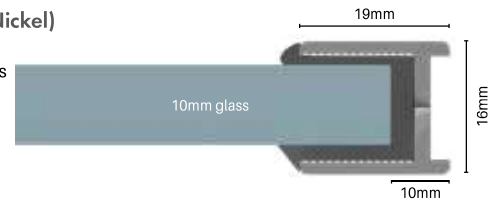
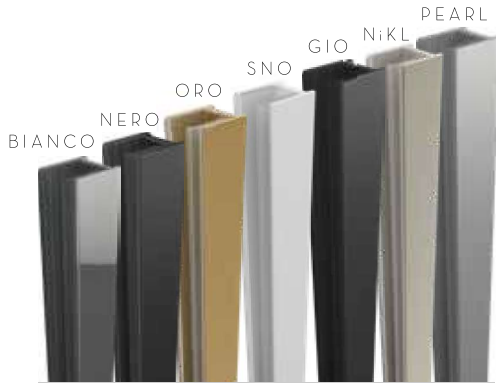

2100mm long

After cutting the U channel to size:

1

Screw the aluminium U channel to wall using counter sunk screws.
(Ensure wall plugs are used if an internal stud cannot be located)
Recommended minimum 3x screw fixings per channel evenly distributed from top to bottom of U channel
(Fixings not supplied - source own fixings depending on substrate)

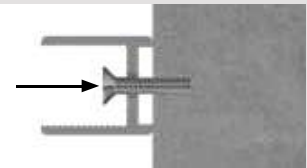

2

Run the L shaped rubber wedge inside the U channel with 'fin' facing inside the shower.
If need be, consider making a hole in PVC where screws are placed to stop PVC bulging out. Screw head must not penetrate past PVC if hole is made.

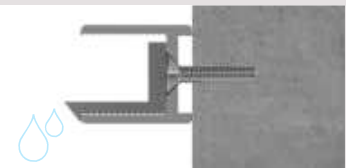

3

Insert 10mm glass panels

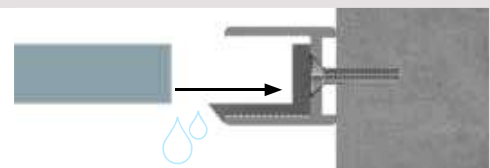

4

With a square offcut of soft pine timber & a rubber mallet, tap in the clear plastic wedge on the outside of the showerscreen, working from the bottom up.

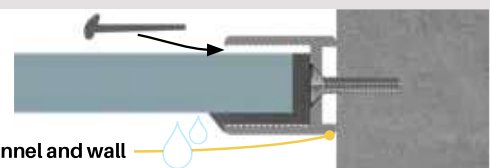

Apply silicone seal between U channel and wall

WE STOCK A RANGE OF
SILICONES & ACCESSORIES





U CHANNELS

Extended U channel – dry glaze, no silicone required

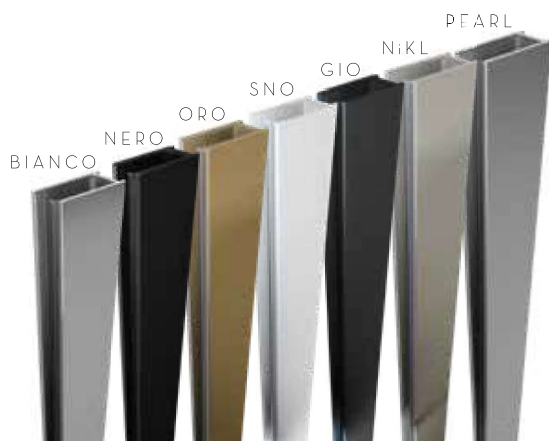

EXTENDED Aluminium U channel

Chrome plated, matt black, brushed brass/gold, matt white, gunmetal, brushed nickel & pearl satin finishes

Order Codes: P-U-2100-EXT (Bianco – Polish)
 PN-U-2100-EXT (Nero – Black)
 P-ORO-U-2100-EXT (Oro Brushed Brass/Gold)
 P-SNO-U-2100-EXT (Sno – White)
 P-GIO-U-2100-EXT (Gio – Gunmetal)
 P-NIKL-U-2100-EXT (Nikl – Brushed Nickel)
 P-PEARL-U-2100-EXT (Pearl satin)

- Extended U channel dry glaze system
- Ideal for use when walls are out of square to a large degree
- Provides extra width if required when installing glass panels
- Allows up to 15mm of width adjustment inside U channel
- *Min. distance glass edge positioned from wall: 10mm
- *Max. distance glass edge positioned from wall: 25mm

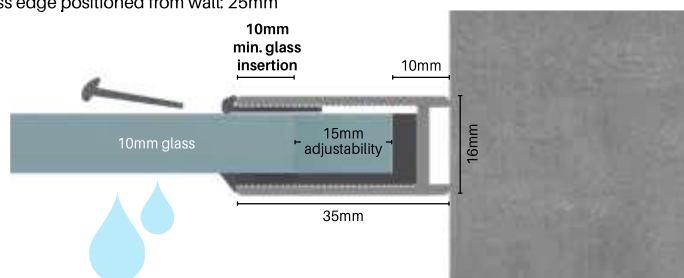

TRADE TIP: Temporarily hold the L-shape rubber in place with tape to assist with glazing the 10mm glass panel.

Wet glaze – silicone required

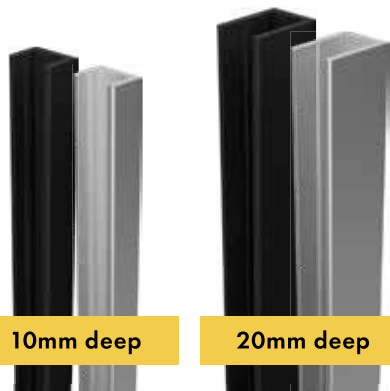

10mm anodised U channel (wet glaze)

Order Code: P-UWET-2500-10MM (2500mm)
 PN-UWET-2500-10MM (2500mm)

20mm anodised U channel (wet glaze)

Order Code: P-UWET-2500-20MM (2500mm)
 PN-UWET-2500-20MM (2500mm)

- Wet glaze U channel system - silicone required
- 2500mm long - adjust length by easily cutting channel
- Suits 8 & 10mm glass
- 2 finishes: Aluminium clear/satin anodise and black anodise
- 2 channel depths: 10mm or 20mm deep
- U channel can be used to secure panels to wall, ceiling or floor
- Commonly used as recess fit into tiles/wall

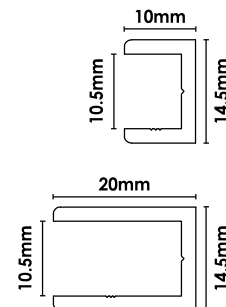

Common installation types

FIX TO WALL, CEILING OR FLOOR

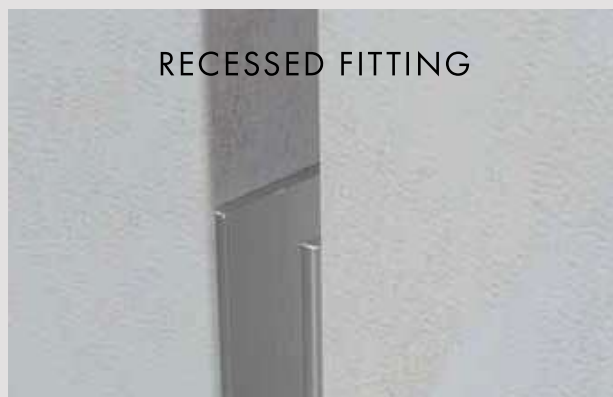



WATER SEALS

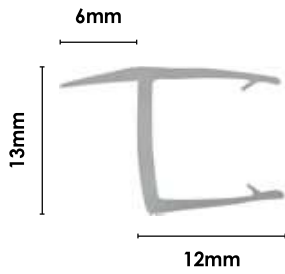

PVC hinge gap water seal

Order Code: P-SH10-2100 (2100mm)

- Water seal between hinge panel and door
- Suits 10mm thick glass
- U section - rigid PVC
- Single leg - 6mm flexible PVC
- Anti-mould additives included in PVC
- Simply snap onto hinge panel
- Available in 2100mm lengths

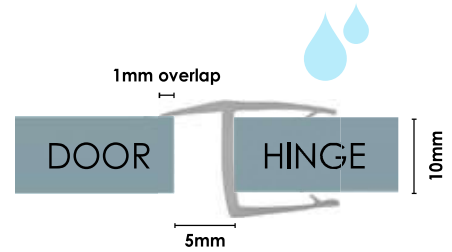

IF NO WATER BAR REQUIRED

OPTION
1

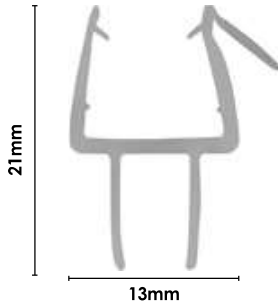

9mm PVC under door water seal

Order Code: P-SD10-0600-09F (600mm)
P-SD10-2100-09F (2100mm)

- Water seal under glass door with 9mm wipes
- Suits 10mm thick glass
- U section - rigid PVC
- 2x vertical leg wipes - 9mm flexible PVC
- 45 degree angle drip rail incorporated
- Anti-mould additives included in PVC
- Simply snap under glass door panel
- Available in 600mm and 2100mm lengths

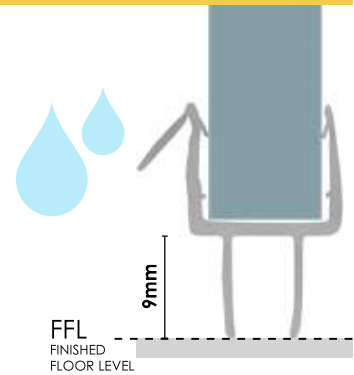

IF USING A ROUND WATER BAR AND UNDER DOOR SEAL

OPTION
2

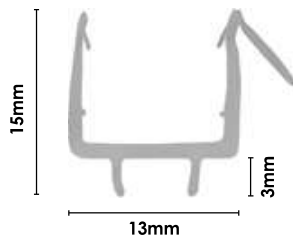

3mm PVC under door water seal

Order Code: P-SD10-0600-03F (600mm)
P-SD10-2100-03F (2100mm)

- Water seal under glass door with 3mm wipes
- Suits 10mm thick glass
- U section - rigid PVC
- 2x vertical leg wipes - 3mm flexible PVC
- 45 degree angle drip rail incorporated
- Anti-mould additives included in PVC
- Simply snap under glass door panel
- Available in 600mm and 2100mm lengths
- Use in conjunction with our anodised aluminium or clear acrylic water bars

Refer option 2A, 2B, 2C
on following page for
use with water bars

IF USING A RECTANGULAR WATER BAR AND UNDER DOOR SEAL

OPTION
3

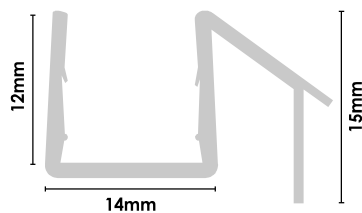

Slimline PVC under door water seal

Order Code: P-SD10-2100-SLIM

- Slimline water seal designed for minimal clearance under door
- Suits 10mm thick glass
- Anti-mould additives included in PVC
- Simply snap under glass door panel
- Designed to be used in conjunction with 9mm high rectangular water bar
- Available 2100mm long

Refer option 3 on p51



WATER BARS

WATER BAR OPTIONS WITH ROUND WATER BAR & 3MM FINS WATER SEAL



POLISH ALUMINIUM ANODISE
Compliments PURITY BIANCO & ZURICH chrome fittings

BLACK ANODISE
Compliments NERO matt black and GIO gunmetal fittings

PEARL SATIN ANODISE
Compliments ZURICH pearl satin

PEARL WHITE
Powder coated aluminium
Compliments SNO matt white fittings

BRUSHED BRASS/ GOLD ANODISE
Compliments ORO brushed gold fittings

BRUSHED NICKEL ANODISE
Compliments Brushed NiKL fittings

OPTION
2A

Slimline aluminium water bar

Order Code: **607mm long**

P-BAR12-0607-PA (Polish aluminium)
P-BAR12-0607-B (Black anodise)

2000mm long

P-BAR12-2000-PA (Polish aluminium)
P-BAR12-2000-B (Black anodise)
P-BAR12-2000-SA (Pearl satin anodise)
P-BAR12-2000-PW (Pearl white)
P-BAR12-2000-ORO (Brushed brass/gold anodise)
P-BAR12-2000-NIKL (Brushed nickel anodise)

- Slimline aluminium water bar: 12mm wide x 6mm high
- Rebated D profile design to allow adhering to floor/base with silicone
- Easily cut to required width
- 607mm wide available in polish and black aluminium only to suit stock panel 600mm wide glass shower door
- 2000mm wide available in all finishes
- *Use in conjunction with 3mm fin under door fin for maximum water seal

OPTION
2A

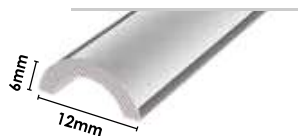
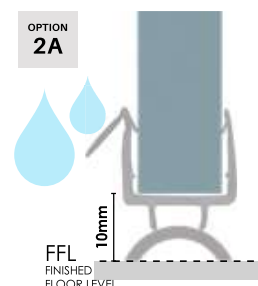

OPTION
2B

Aluminium water bar

Order Code: **P-BAR-0607-PA (Polish aluminium)**
P-BAR-2100-PA (Polish aluminium)

- Anodised aluminium water bar
- Polish finish
- Rebated D profile design to allow adhering to floor/base with silicone
- Available in 607mm and 2100mm lengths
- 607mm pre-cut to door opening for stock panel 600mm wide door
- *Use in conjunction with 3mm fin under door fin for maximum water seal

OPTION
2B

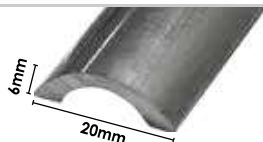
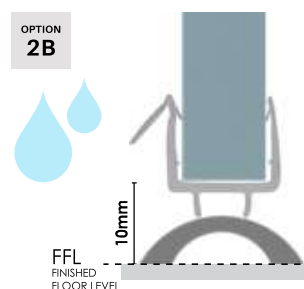

OPTION
2C

Clear acrylic water bar

Order Code: **P-BAR-0607-A (600mm)**
P-BAR-2100-A (2100mm)

- Clear acrylic water bar
- Rebated D profile design to allow adhering to floor/base with silicone
- Available in 607mm and 2100mm lengths
- 607mm pre-cut to door opening for stock panel 600mm wide door
- *Use in conjunction with 3mm fin under door fin for maximum water seal

OPTION
2C

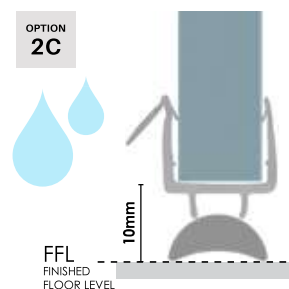





WATER BARS

WATER BAR OPTIONS WITH SQUARE WATER BAR & 3MM FINS SLIMLINE WATER SEAL

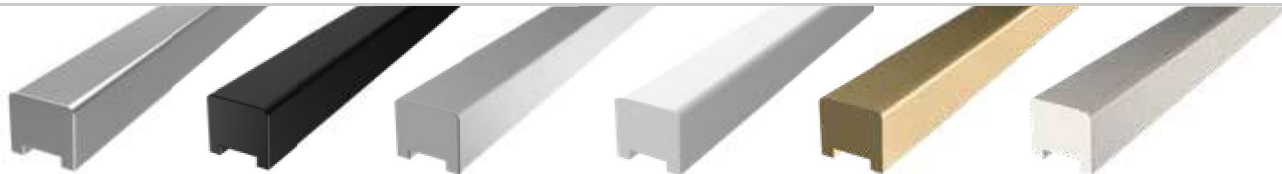

POLISH ALUMINIUM ANODISE
Compliments PURITY BIANCO & ZURICH chrome fittings

BLACK ANODISE
Compliments NERO matt black & GIO gunmetal fittings

PEARL SATIN ANODISE
Compliments ZURICH pearl satin

PEARL WHITE
Powder coated aluminium
Compliments SNO matt white fittings

BRUSHED BRASS/ GOLD ANODISE
Compliments ORO brushed gold fittings

BRUSHED NICKEL ANODISE
Compliments Brushed NiKL fittings

OPTION 3

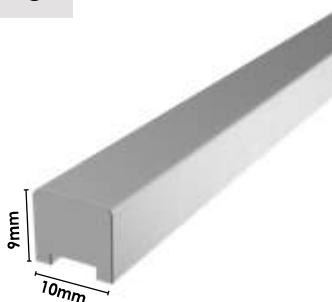

Rectangular water bar

Order Code: P-BAR10SQ-2000-PA (Polish aluminium)
P-BAR10SQ-2000-B (Black anodise)
P-BAR10SQ-2000-SA (Pearl satin anodise)
P-BAR10SQ-2000-ORO (Brushed brass/gold anodise)
P-BAR10SQ-2000-NIKL (Brushed nickel anodise)
P-BAR10SQ-2000-PW (White powdercoat)

- 10mm wide x 9mm high aluminium water bar
- Rebated bottom design to allow adhering to floor with silicone
- Easily cut to width required
- 2000mm wide
- Use in conjunction with slimline under door seal for maximum water seal (Code: P-SD10-2100-SLIM)

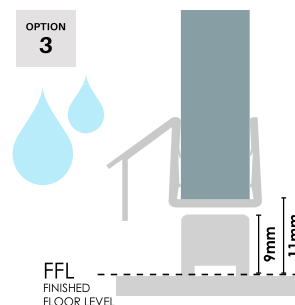



EXTRAS & ACCESSORIES



Soudal kitchen/ bathroom silicone

TRANSLUCENT – 300mL
Order Code: SOUD-KBS-TRANS

- Translucent finish
- High quality, neutral cure silicone
- Easy to smooth & finish
- For sealing, waterproofing and bonding applications
- Contains mould & mildew inhibitors
- Colourfast and UV resistant
- Strong adhesion to glass, tile, ceramics, aluminium, metals (including powder-coated & anodised), painted surfaces, fibreglass, stainless steel
- Use standard caulking gun



Soudal kitchen/ bathroom silicone

WHITE – 300mL
Order Code: SOUD-KBS-W

- White finish
- High quality, neutral cure silicone
- Easy to smooth & finish
- For sealing, waterproofing and bonding applications
- Contains mould & mildew inhibitors
- Colourfast and UV resistant
- Strong adhesion to glass, tile, ceramics, aluminium, metals (including powder-coated & anodised), painted surfaces, fibreglass, stainless steel
- Use standard caulking gun



Soudal all purpose silicone

300mL
Order Code: SOUD-APS-B

- Black finish
- High quality, neutral cure silicone
- Ultimate all rounder silicone (roof/gutter, kitchen/bathroom, glass/glazing)
- For sealing, waterproofing & bonding applications
- Strong adhesion to ceramics, glass, aluminium (including powder coated & anodised), PVC, stainless steel, zinc & galvanised coated surfaces, timber, concrete, fibreglass, laminate, painted surfaces, etc
- UV resistant with very good mould resistance (biocide with fungicidal action)
- Water potable & food safe
- Use standard caulking gun



Bostik 6S

300G – TRANSLUCENT
Order Code: P-S-6S

- Translucent finish
- High performance neutral cure silicone sealant
- Contains a mould and mildew inhibitor
- Seals water tight – UV and weather resistant
- Designed for use in showers, baths, sinks and laundries

Compatible substrates:

- Glass
- Ceramic tiles
- Grout
- Aluminium
- Steel
- Masonry
- Most plastics

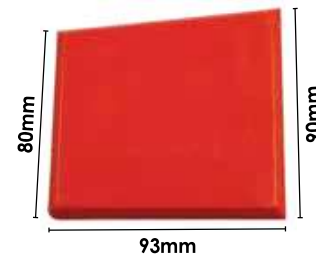

Purity silicone spatula

MEDIUM FLEXIBILITY

Order Code: P-SS

- Handy tool for glazing panels with silicone
- Made from thermoplastic polyurethane – good elasticity and resistant to oils, grease & abrasion
- 1 x corner features radius (R4) for neat silicone finishing



PACK OF
100

Purity clear setting blocks

1.5mm x 12mm x 50mm

Order Code: P-SB

- Position under glass panels to separate bottom edge of glass from floor



Glass gloves – pair of 2

ONE SIZE FITS ALL

NOT FOR USE WHEN WET

Order Code: GLOVE



Ultraloc Threadlocker 3242 compound

10ML BOTTLE

Order Code:

ULTRALOC-3242

- Medium strength removable grade threadlocking compound for metal screws, nuts and fasteners from 6mm to 20mm in diameter



EXTRAS & ACCESSORIES



Tile drill bit

Tungsten carbide bit

Order Code: P-BIT-6MM (6mm)

P-BIT-7MM (7mm)

P-BIT-8MM (8mm)

- Available in 6mm, 7mm or 8mm diameter
- For smooth drilling into ceramic tiles, brick, fibreglass & plastics
- Tungsten carbide bit with copper brazing
- Diamond facet spear point for precision penetration
- Bits fit into standard drills

THE PERFECT FINISH EVERYTIME.



Our new hardware swatches allow for clients to select the perfect finish everytime. Compact & portable for meetings or for your showroom display.

Contact us for more info

Swatch Set

Order Code: P-SWATCH

- Swatch set in white carry bag
- 50mm diameter swatches of 7 x finishes: Chrome; Pearl satin; Gio gun metal; Nikl brushed nickel; Oro brushed brass/gold; Sno white; Nero black
- Ideal for showing hardware colour finish options available