

BLITZ GLASS

Balustrading Aluminium Systems



www.blitzglass.com.au



(07) 5493 9779



admin@blitzglass.com.au

A photograph of a modern balcony with a dark aluminum railing. The railing consists of vertical bars and a top rail. The balcony floor is made of light-colored tiles. In the background, there is a harbor with many boats and buildings on the shore. The sky is clear and blue. The text "ALUMINIUM BALUSTRADE SYSTEMS" is overlaid on the top left of the image.

ALUMINIUM BALUSTRADE SYSTEMS

ALUMINIUM BALUSTRADE INNOVATION

Introduction

We offer a suite of aluminium systems sit at the intersection of style and innovation. Designed with labour saving technology in mind and non-weld assembly/installation, simply select post and handrail and then select between 5 infill styles.

All systems have engineer compliance certification. Contact us for details.

SAVE TIME AND
MONEY WITHOUT
COMPROMISE
ON QUALITY
OR STYLE.

01 STEP 1 / SELECT POST & HANDRAIL*

- (A) Core drill or base plate posts
- (B) Face mount posts
- (C) Oval or rectangular handrails* (*not required for Barr balustrade)

02 STEP 2 / SELECT INFILL

(same post & handrails used with all infills)

- (A) Barr balustrade
- (B) AIRE™ Square picket baluster (16.5x16.5mm)
- (C) AIRE™ Vertical slat balustrade (65x16.5mm)
- (D) Horizontal slat balustrade (65x16.5mm)
- (E) Premium Perforated sheet

03 STEP 3 / INSTALL

Enjoy the benefits of non-weld assembly with a superb finish.



'MIX & MATCH' SYSTEMS

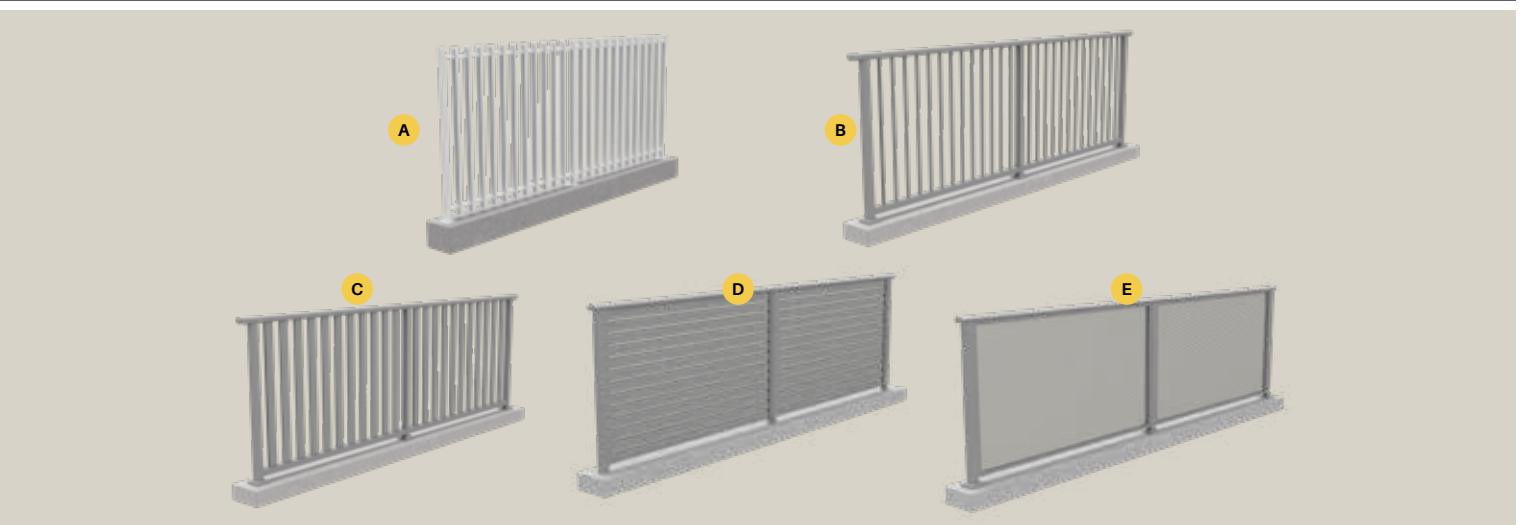
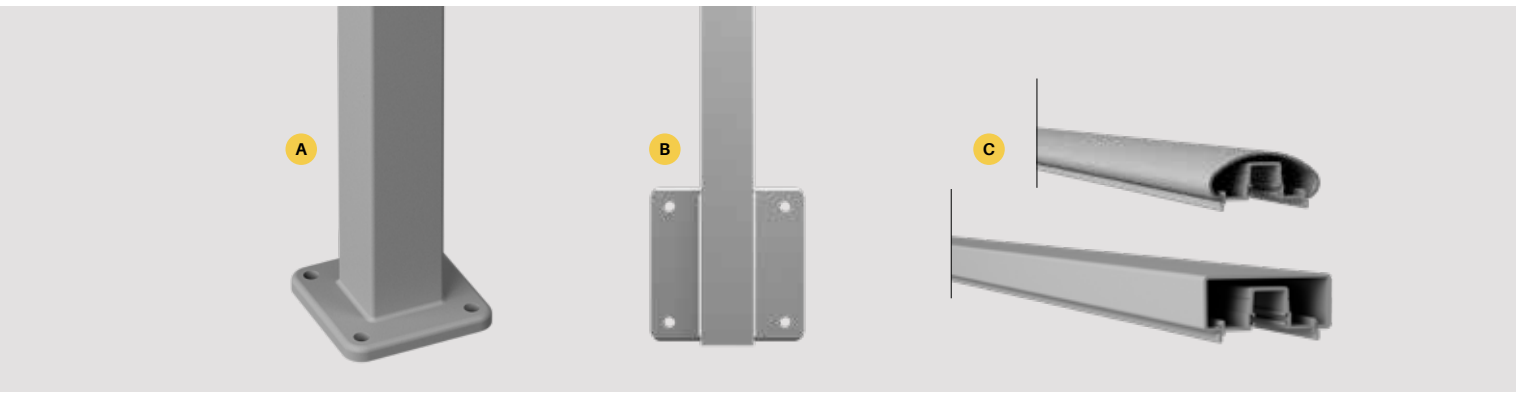

INTRODUCING VISOR™

We are proud to introduce a new architecturally inspired balustrade system **Visor™** – where no welding is required! This stunning new balustrade system incorporates innovative and unique features, blending functionality, safety, and aesthetic appeal. The modern and highly stylish **Visor™** uses 50mm x 10mm vertical balusters with 90mm spacings and is available in **Matt Black, Pearl Matt White or Mill finish.**

Visor™ reflects a clean, minimalist design with streamlined profiles and simple geometric shapes. This design approach focuses on simplicity and elegance.

Visor™ not only provides a safe and functional balustrade system, but also contributes to the overall design and aesthetics of a space. The system can be tailored to suit different architectural styles, from modern and contemporary to traditional and ornate.

The system features face-mount and deck mount applications. **Visor™** allows for a continual run of 50mm x 10mm balusters without the need for vertical posts to secure handrail and balusters.

When designing a modern balustrade system, it's important to consider the overall architectural style and ensure that the balustrade harmonises with the surrounding environment. **Visor™** is a functional and visually stunning modern balustrade solution.

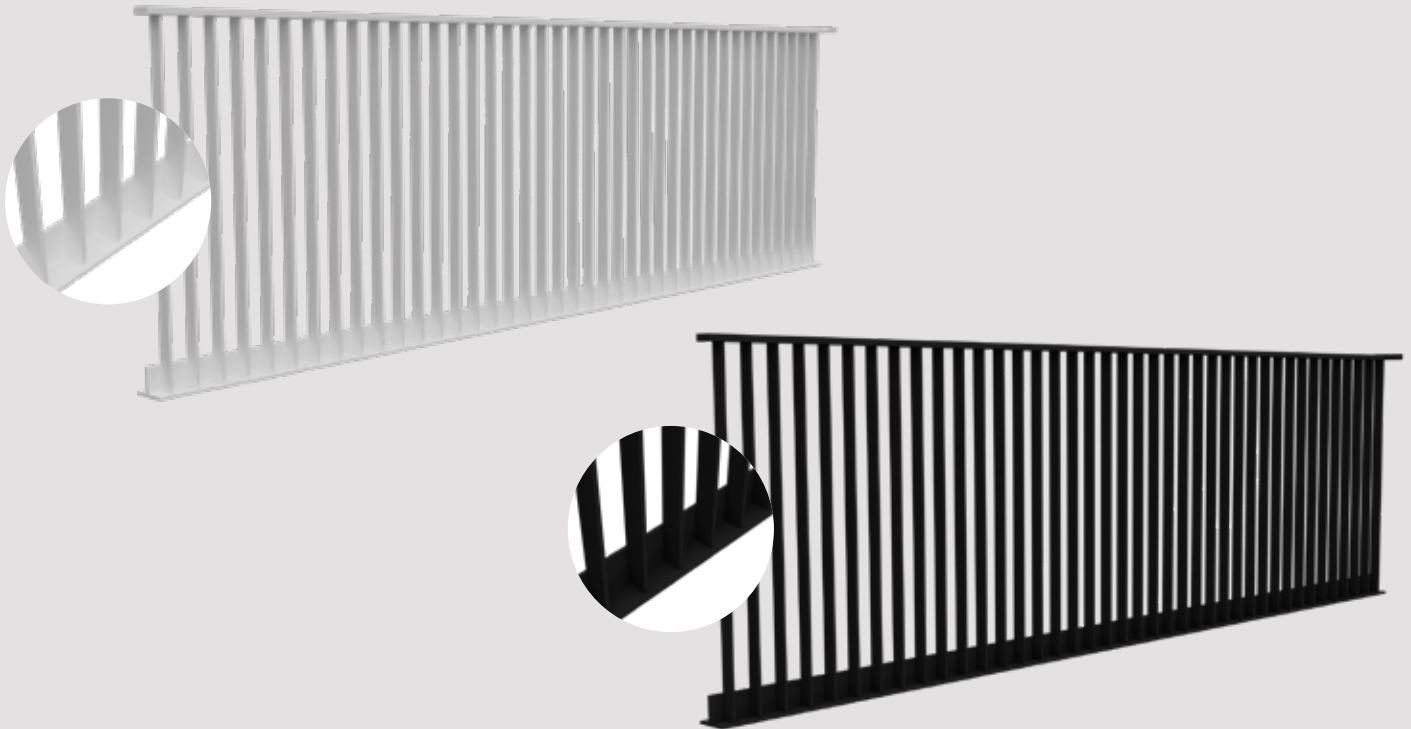

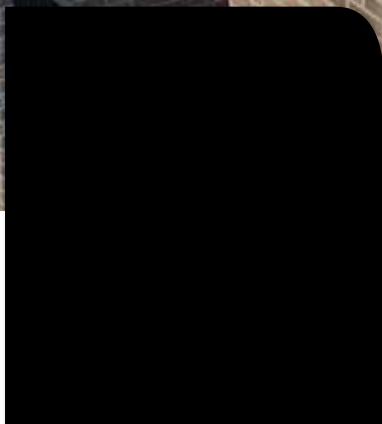

FLAT MATT BLACK / YN21BA (B)
Interpon D2525 powder coat

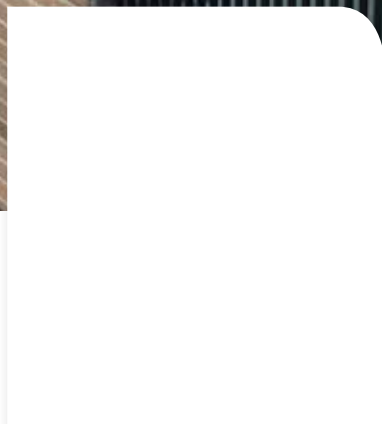

PEARL WHITE MATT / YA278A (W)
Interpon D2525 powder coat



MILL (M)
Ready to powder coat

Note: Colours displayed are a guide only

Why choose Visor™?

Modern balustrade systems are known for their sleek, clean lines and contemporary design elements. They can enhance the overall visual appeal of a space, adding a touch of sophistication and elegance. Visor™ can become a focal point, complementing the architectural style and creating a sense of modernity.



VISOR™ FACE MOUNT OVERVIEW

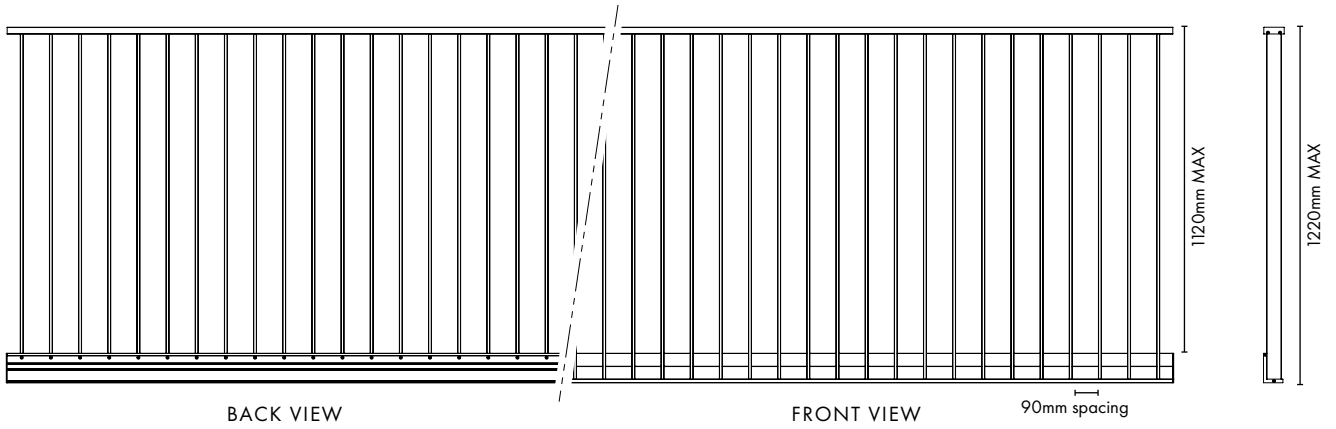

- 1 Handrail offset bracket
- 2 70x23mm rectangular handrail
- 3 70x23mm handrail end plate
- 4 8Gx25mm countersunk SS304 screw
- 5 14Gx50mm pan head SS304 screw
- 6 Handrail friction insert
- 7 Handrail under-capping plate (slotted)
- 8 50mm x 10mm baluster
- 9 Face-mount profile (pre-drilled)
- 10 Face-mount end plates
- 11 14Gx50mm pan head SS304 screw
- 12 12Gx50mm pan head SS304 screw
- 13 Face-mount bottom cover

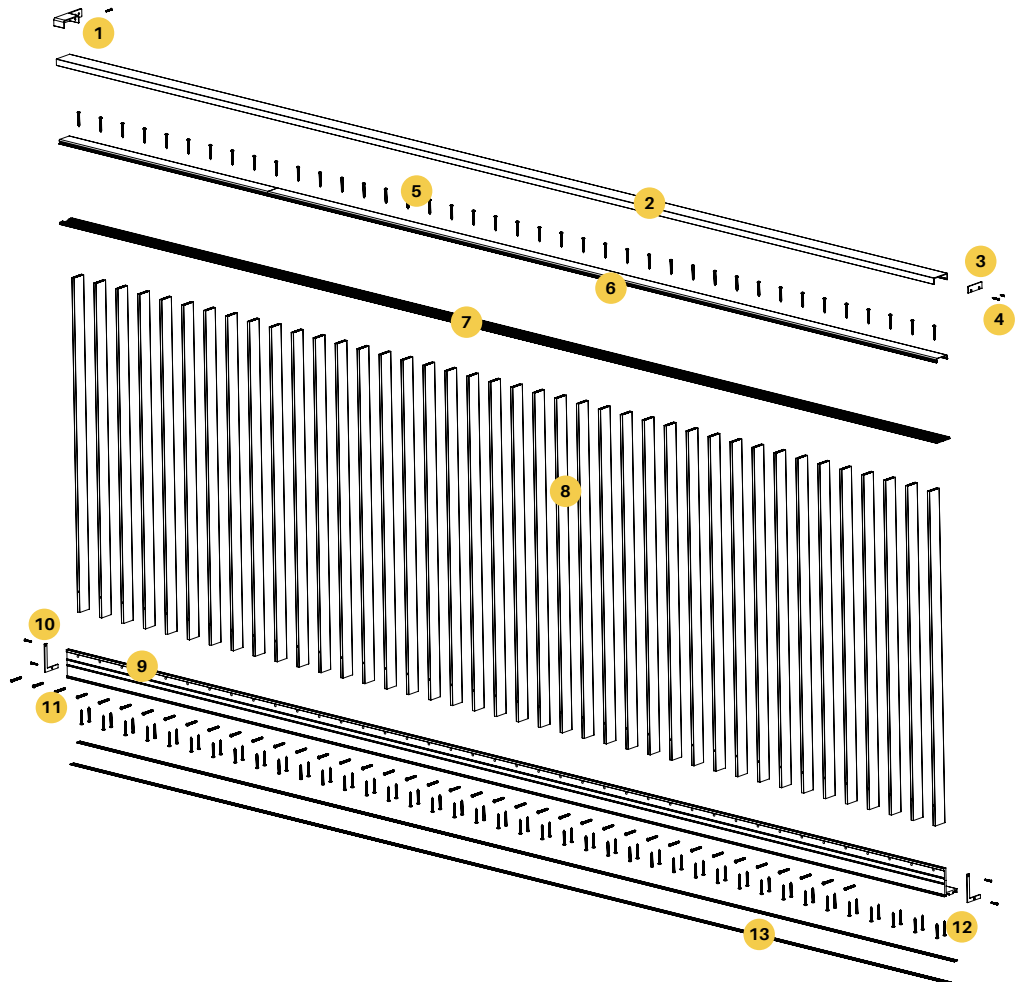

VISOR™ DECK MOUNT OVERVIEW

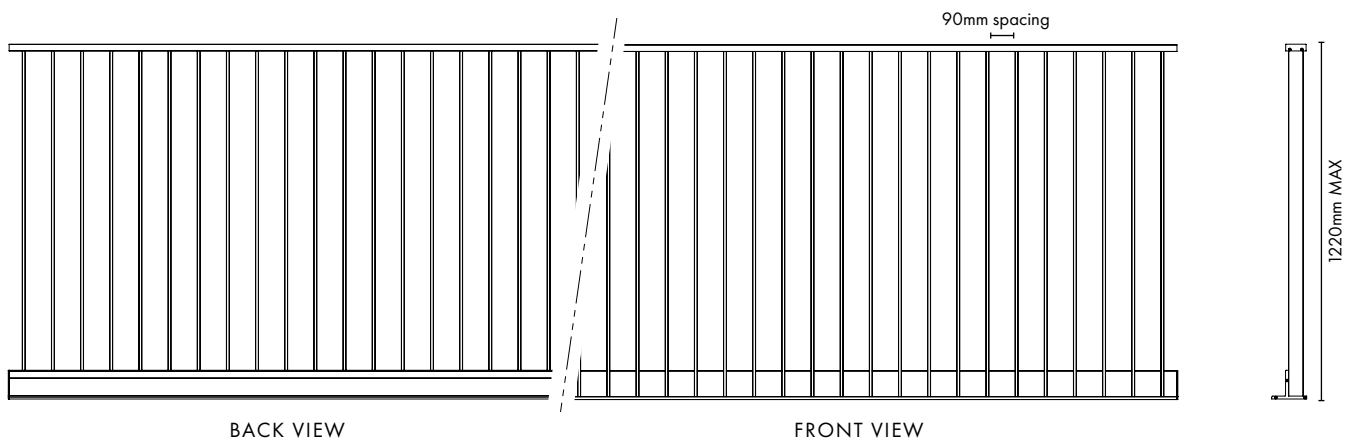

- 1 Handrail offset bracket
- 2 70x23mm rectangular handrail
- 3 70x23mm handrail end plate
- 4 8Gx25mm countersunk SS304 screw
- 5 14Gx50mm pan head SS304 screw
- 6 Handrail friction insert
- 7 Handrail under-capping plate (slotted)
- 8 50mm x 10mm baluster
- 9 Deck-mount profile (pre-drilled)
- 10 Deck-mount end plates
- 11 14Gx50mm pan head SS304 screw
- 12 12Gx50mm pan head SS304 screw
- 13 Deck-mount side cover

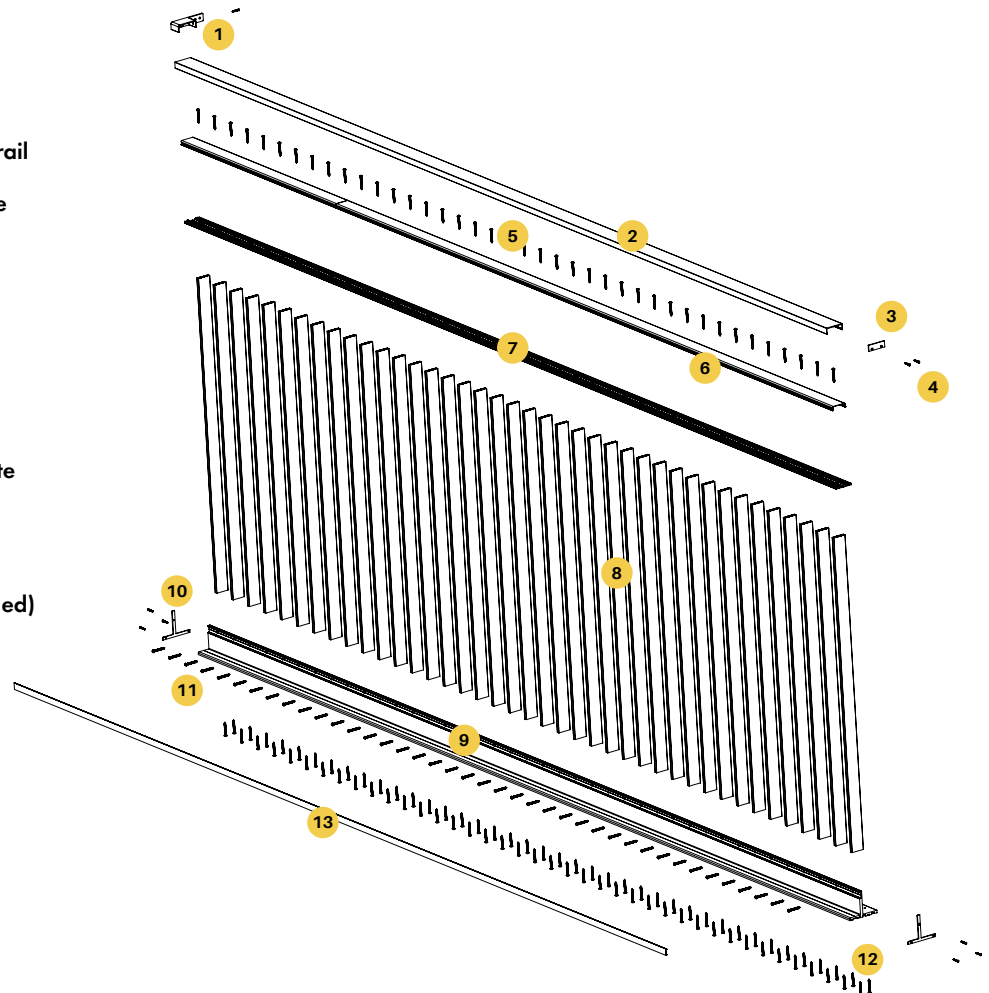

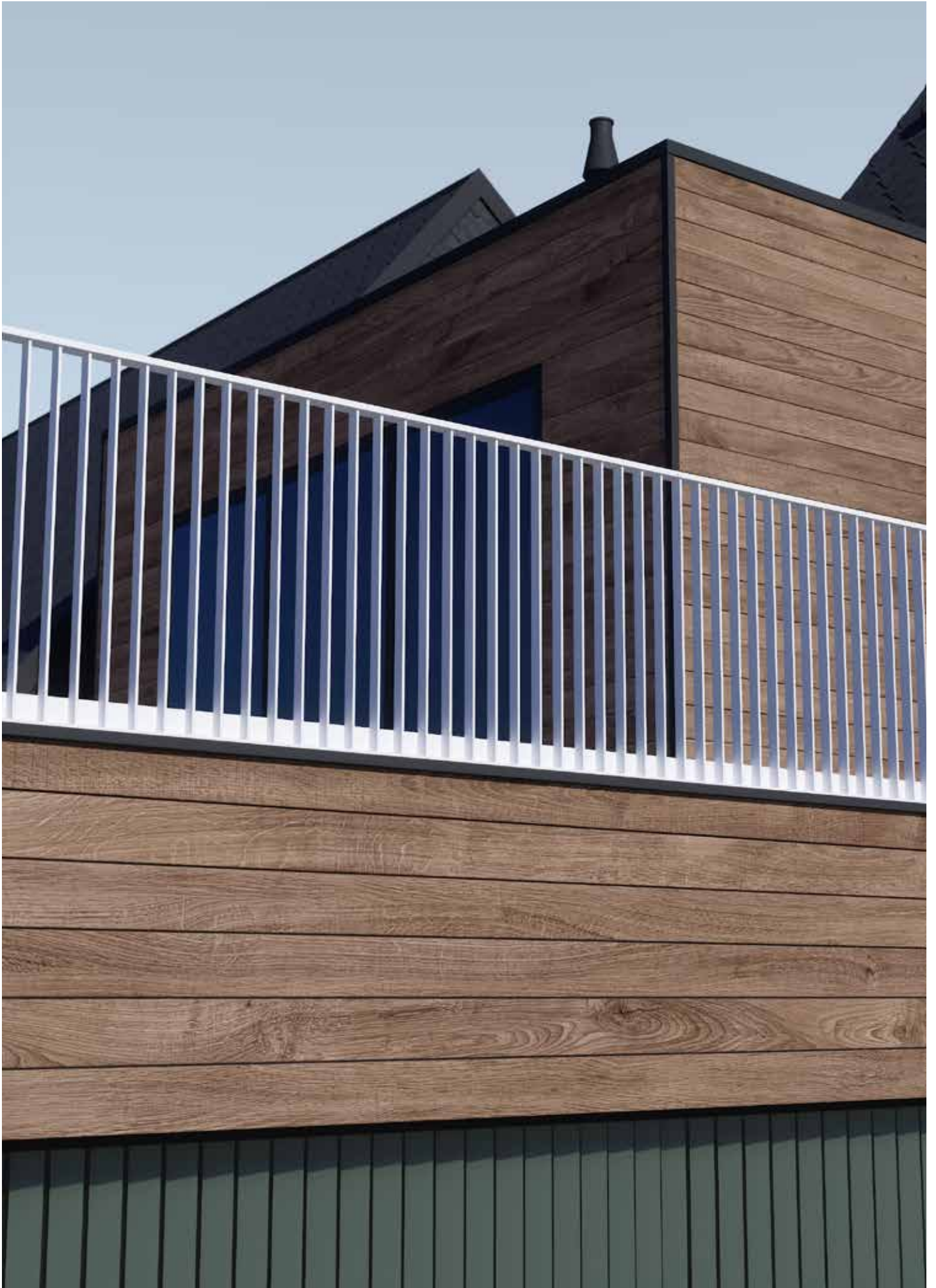

Visor™ can be used in various architectural settings, both residential and commercial. It can be integrated into indoor or outdoor spaces, such as staircases, balconies, terraces, or mezzanines. The versatility of Visor™ allows it to blend seamlessly with different architectural styles, whether it's a contemporary building or a renovation project.



NOTE – Select finish code:
(EG VIS-4000-DECK-B for black)

ORDER CODES

Order Code	Description	Colours
VIS-1200-BAL-B/W/M-4PK	Aluminium 50x10mm baluster – 1200mm high (4 pack)	  
VIS-6100-BAL-B/W/M	Aluminium 50x10mm baluster – 6100mm long	  
VIS-4000-DECK-B/W/M	Aluminium deck mount 'T' profile – 4000mm long	  
VIS-4000-COV-DECK-B/W/M	Aluminium side cover profile – 4000mm long	  
VIS-4000-FACE-B/W/M	Aluminium face mount 'L' profile – 4000mm long	  
VIS-5000-FM-NM-M	Aluminium face mount 'L' profile – non machined – 5000mm long	
VIS-4000-COV-FACE-B/W/M	Aluminium bottom cover slide in profile – 4000mm long	  
VIS-4000-PLATE-B/W/M	Aluminium undercapping plate – 4000mm long	  
VIS-4942-PLATE-R-B/W/M	Aluminium undercapping plate – raked – 4942mm long	  
VIS-3050-INS-2PK	Aluminium friction insert – 3050mm long (2 pack)	 *Clear anodised
VIS-6100-HRAIL-B/W/M	Aluminium rectangular handrail – 70x23mm – 6100mm long	  
VIS-BRACKET-B/W/M-2PK	Aluminium offset bracket (2 pack)	  
VIS-EP-B/W/M	Aluminium 70x23mm handrail end plate	  
VIS-WB-B/W/M	Aluminium 63x20mm wall/post bracket	  
VIS-DMEP-B/W/M-2PK	Aluminium 'T' deck mount end plates (2 pack)	  
VIS-FMEP-B/W/M-2PK	Aluminium 'L' face mount end plates (2 pack)	  
VIS-J-M	Aluminium inline joiner for handrail friction insert	
VIS-J90-M	Aluminium 90 degree joiner for handrail friction insert	
VIS-SCR-BAL-50PK	12g x 50mm panhead screw (50 pack)	
VIS-SCR-SIDEBAL-50PK	14g x 50mm panhead screw (50 pack)	
VIS-SCR-CSK-50PK-B/W	8g x 25mm countersunk phillips head screw (50 pack)	  
DB-PH3	Driver bit phillips #3	
DB-SQ3.4	Square head driver bit	

 MATT BLACK  MATT WHITE  MILL

BARR BALUSTRADE

Why choose BARR?

Elevate aesthetics and functional living spaces with BARR – the brand new and ingeniously designed 50x25mm vertical baluster aluminium balustrade system. Pushing the boundaries of modern design and craftsmanship, we've revolutionised traditional balustrade systems.



1. STREAMLINED INTEGRATION

The horizontal top and bottom rails seamlessly pass through expertly machined holes in the balusters, ensuring a sleek appearance and superior structural integrity.



2. ROBUST ALUMINIUM BUILD

Durability meets design. Our balusters are crafted from high-grade aluminium, ensuring long-lasting performance without compromising on elegance.



3. SPACE-SAVVY DESIGN

With a slim 50x25mm profile, vertical balusters provide a visually expansive feel, making spaces look bigger and more open, while ensuring safety and sturdiness.



4. EASY INSTALLATION

Panels are fully welded and ready to install with slimline brackets at each end. Install utilising sturdy core drill, deck mount or face mount posts.



5. MAINTENANCE SIMPLICITY

With its corrosion-resistant properties, our aluminium balustrade system promises minimal upkeep, retaining its shine and strength for years to come.



6. COMPLIANCE

Contact us for engineer compliance certification.



BARR BALUSTRADE

01 **BARR Core Drill**

50x50mm core drill posts featuring welded BARR 50x25mm balustrade infill panels

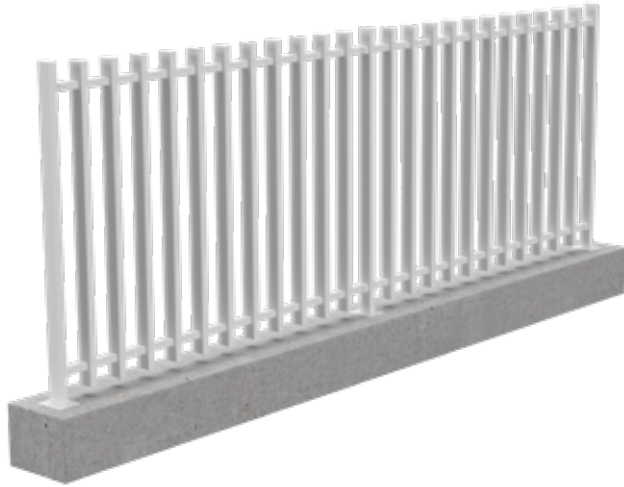

02 **BARR Base Plated**

50x50mm base plated posts featuring welded BARR 50x25mm balustrade infill panels

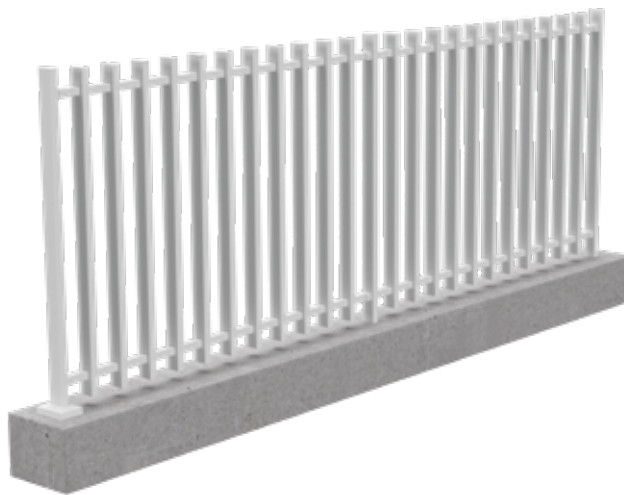

03 **BARR Face Mount**

50x50mm face mounts posts (including end and mid posts) with welded BARR 50x25mm balustrade infill panels

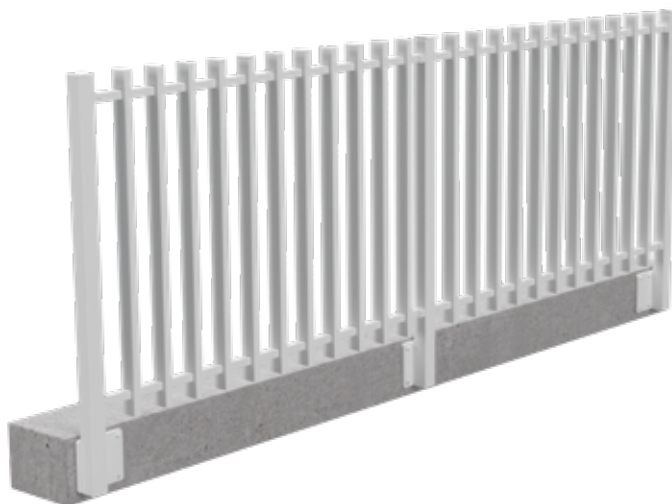

FINISHES

Our colour range

BARR is stocked in 2 popular balustrade powder coat finishes: Satin Black and Pearl White Gloss.

Satin black and pearl white continue to be the consistent colour palate for balustrade and seamlessly integrate into a variety of backgrounds. Pearl white is a growing trend in balustrade with the proliferation of Hamptons inspired design.

Genuine Interpon powder is used with Interpon D1000 manufacturer warranties provided.

BARR extrusions are produced to the chemical composition, mechanical property and dimensional tolerances in AS-NZS 1866:1997

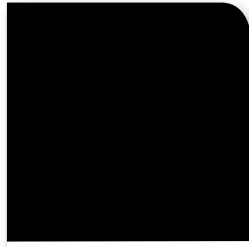

SATIN BLACK
GN150A (B)

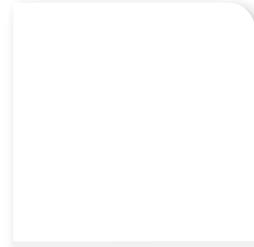

PEARL WHITE GLOSS
GA078A (W)



BARR BALUSTRADE

- 1 50x50mm posts: Core drill, base plated or face mount
- 2 Extended 'C' brackets
- 3 SS304 bracket fixing screws
- 4 1000mm high panel with welded 50x25mm balusters
(or 1200mm high panel option for face mount installations)

CORE DRILL

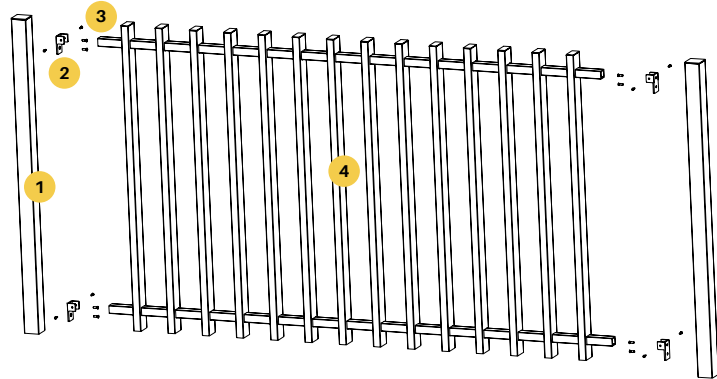

BASE PLATED

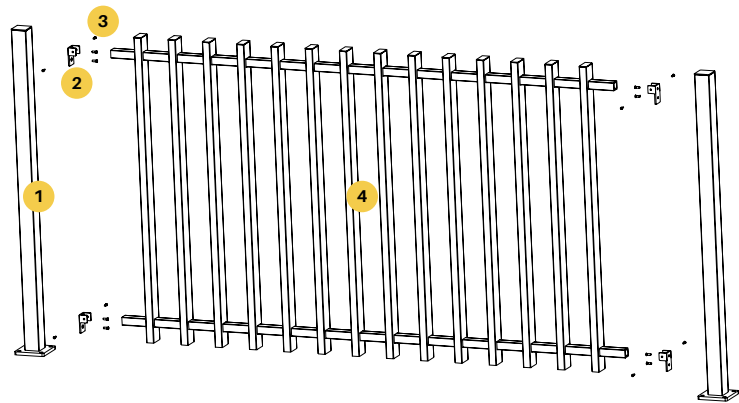

FACE MOUNT

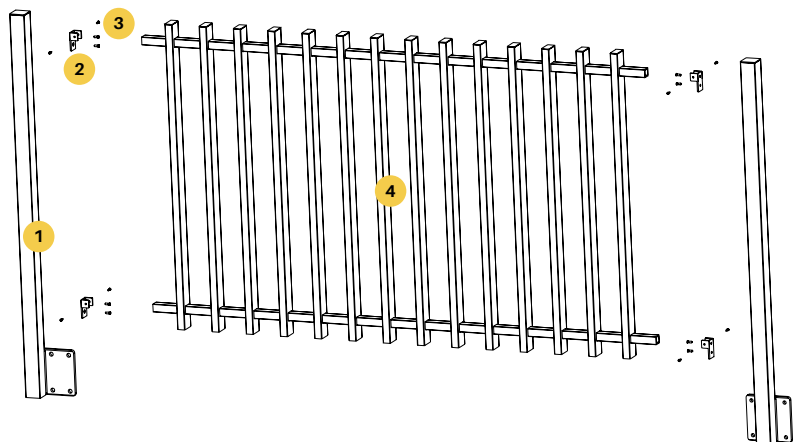

WATCH THE VIDEO

www.glassoutlet.com.au/product-videos















NOTE – Select finish code:
(EG AR-1050-FPBP-B for black)

ORDER CODES

Order Code	Description	Colours
AR-1050-FPBP-B/W	1050mm high – full post with base plate (welded)	 
AR-5800-FP-B/W	5800mm long – full post	 
AR-1500-FMID-B/W	Mid face mount post – 1500mm H	 
AR-1500-FMLR-B/W-2PK	Face mount – left & right – 1500mm H	 
BR-PANEL-1733-1000-B/W	Barr 50 x 25 panel – 1000mm H x 1733mm W	 
BR-PANEL-2205-1200-B/W	Barr 50 x 25 panel – 1200mm H x 2205mm W	 
BR-TCA-B/W	Barr top cap	 
XP-TP-B/W	50 x 50mm post flat top plate	 
BR-BR60-B/W-4PK	Barr extended 'C' bracket kit	 
XP-DR-B/W	50 x 50mm post dress ring	 
XP-DC-2P-B/W	Two part domical cover	 
DB-PH3	Phillips #3 driver bit	
DB-SQ3.4	Square head driver bit	
S-110LAG-4PK	M10 x 110mm long timber lag screw – 4 pack	
S-120ROD-4PK	M10 x 120mm thread rod with nuts/washers – 4 pack	
SOUD-CA1400	Soudafix CA1400 chemical anchor	
SOUD-GUN	Soudal heavy duty cartridge gun	
PAINT-B/W	Touch up paint	 
HSP-75X38-1MM-20PK	Horseshoe packers – 1mm thick	
HSP-75X38-3MM-20PK	Horseshoe packers – 3mm thick	
GS-DN-4PK-B/S	M12 dome nut – pack of 4	 

 MATT BLACK  MATT WHITE  MILL

AIRE™

Why choose AIRE™?

AIRE™ is a complete aluminium picket balustrade system featuring innovative patented non-weld technology and is ideally suited for new builds or renovations. This stunning system features either vertical 16.5mm square or 65x16.5mm slat balusters coupled with sturdy 50x50mm posts and the option of either a rectangular or oval handrail.

Careful design considerations ensure the system seamlessly integrates providing a complete aluminium balustrade suite that is easy to assemble and install in either core drill or base plated application.

The system is stocked in 3 popular powder coated finishes – satin black, monument matt and pearl white gloss. It is also available in mill finish allowing customisation of powder coat colour. Pre-powder coated material can be cut to required lengths and assembled onsite or in a factory. The installation process has been carefully considered with component parts designed to maximise visual appeal while still ensuring ease of install.

The AIRE™ system is the result of significant research and development coupled with extensive load testing by accredited NATA testing facilities. Importantly, engineer compliance certification is available.

AIRE™ is a game changer in aluminium picket balustrade.

Certification

Certificate of Compliance to load test requirements of AS/NZS 1170.0, AS/NZS 1170.1 and NCC2022. Contact us for engineering information.

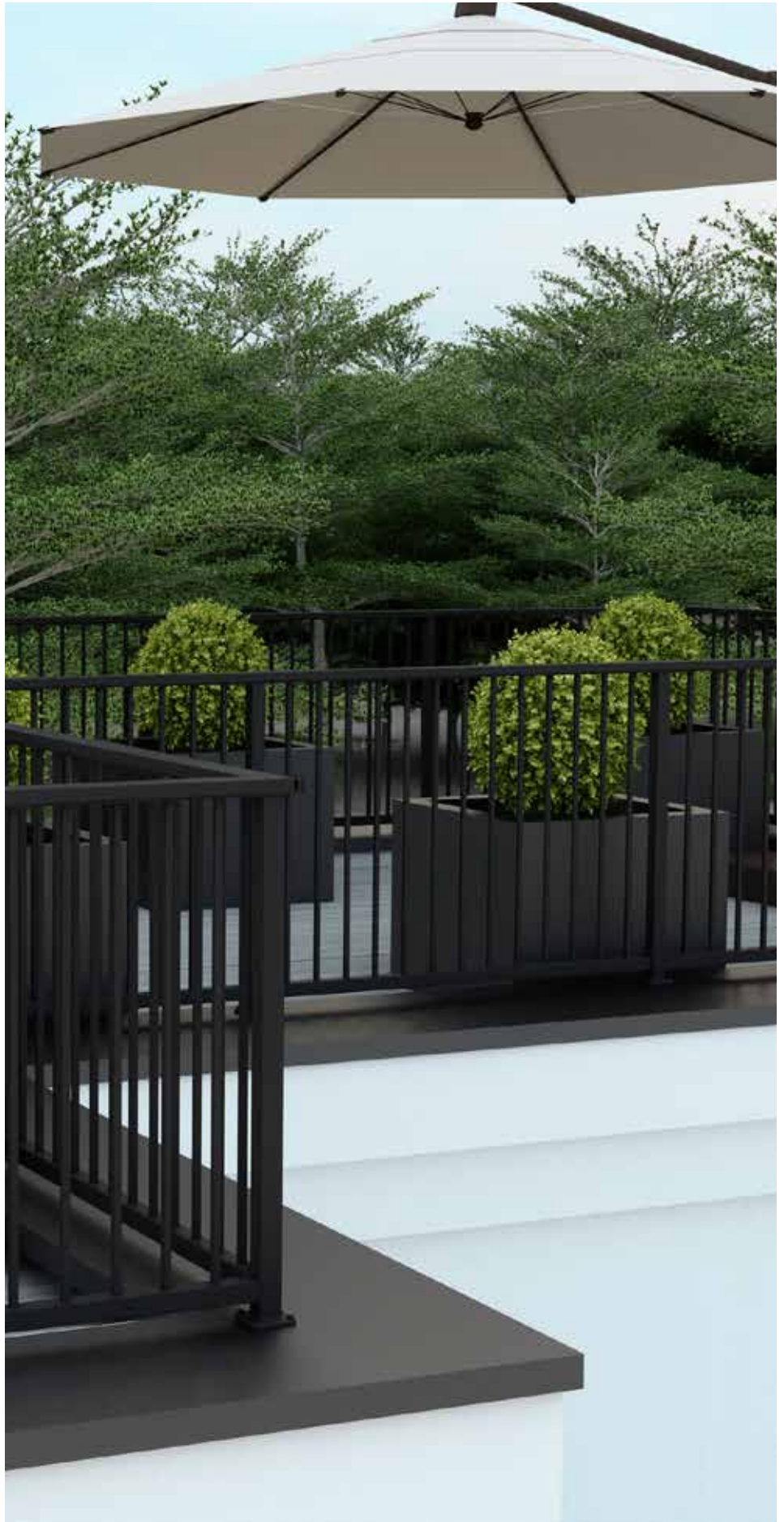

FINISHES

Our colour range

AIRE™ is stocked in 3 popular balustrade powder coat finishes: Satin Black, Monument Matt and Pearl White Gloss. Mill finish is also available enabling customisation to any desired powder coat finish.

Satin black and monument matt continue to be the consistent colour palate for balustrade and seamlessly integrate into a variety of backgrounds. Pearl White is a growing trend in balustrade with the proliferation of Hamptons and coastal living inspired design.

Genuine Interpon powder is used with Interpon D1000 manufacturer warranties provided.

AIRE™ extrusions are produced to the chemical composition, mechanical property and dimensional tolerances in AS-NZS 1866:1997

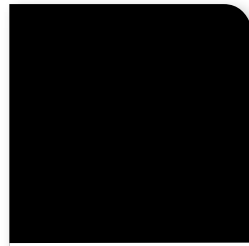

SATIN BLACK
GN150A (B)

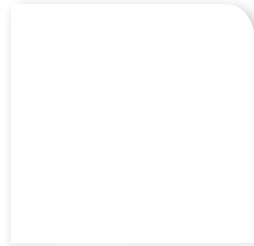

PEARL WHITE GLOSS
GA078A (W)



MONUMENT MATT
GL229A (MN)



MILL (M)
Ready to powder coat



STYLES OF AIRE™



01 AIRE™ Picket Full

The ultimate in picket balustrade – featuring 16.5x16.5mm square balusters with oval or rectangular handrail option.



02 AIRE™ Picket 3-Rail

Features a stylish midrail design incorporating 16.5x16.5mm square balusters and choice of oval or rectangular handrail.



03 AIRE™ Slat Full

Vertical slat 65x16.5mm slat balusters with 64mm gap spacing. Increasingly popular having regard to Hamptons inspired design.



04 AIRE™ Slat 3-Rail

Midrail option for 65x16.5mm vertical slat balustrade.



05 AIRE™ balustrade featuring face mount posts

Face mount posts feature (i) offset plates for installation at end of runs and (ii) centrally positioned plates for mid spans.

AIRE™

- 1 **75x30mm top rail**
(available oval or rectangle profile)
- 2 **Undercapping rail**
- 3 **75x30mm end cap**
- 4 **10gx16mm fixing screw for end cap**
- 5 **Snap in spacers**
- 6 **12gx20mm hex flange self drilling screw**
- 7 **16.5x16.5mm square pickets/balusters**
- 8 **Punched insert (92.5mm gap spacing)**
- 9 **45x45mm bottom rail**
(also used as midrail for 3 rail installations)
- 10 **12gx25mm screws for:**
1) Fixing rail mounting plates to posts
(**for fixing to aluminium posts. Use different/appropriate screws if fixing to timber/steel etc)
2) Bottom rail locking screen
3) Fixing undercapping rail to posts
- 11 **Mounting plates**
- 12 **12gx50mm screws for fixing mounting plates to bottom rail**
- 13 **50x50 AIRE™ post**
(core drill, welded base plate or face mount posts)
- 14 **2 part domical cover**
(**if using base plated posts; use dress ring if core drill post)

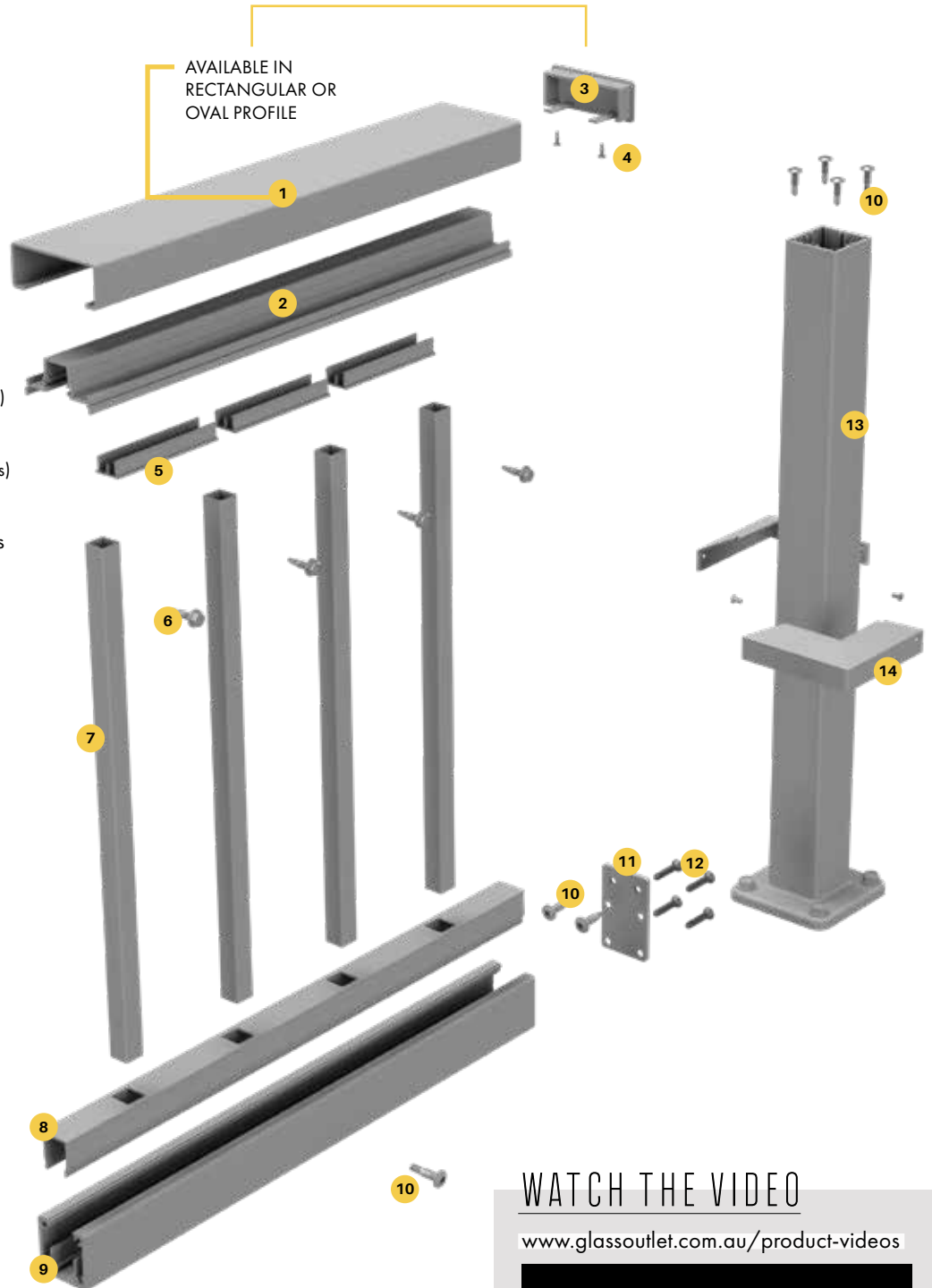

WATCH THE VIDEO

www.glassoutlet.com.au/product-videos

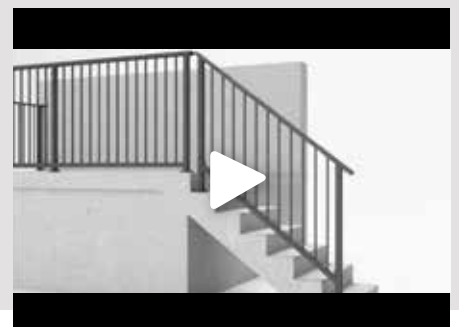

AIRE™ SLAT

AIRE™ slat range

Versatile design providing the sought after Hamptons look with 65x16mm vertical slat balusters. Also, achieve a stunning colonial look with the '3 rail configuration' by incorporating a midrail.

- ✔ Complete balustrade system featuring non-weld technology
- ✔ Core drill, base plated or face mount application
- ✔ Pre-powder coated stock is easily assembled & installed
- ✔ Option for raked installation for staircases
- ✔ Compliance certification available

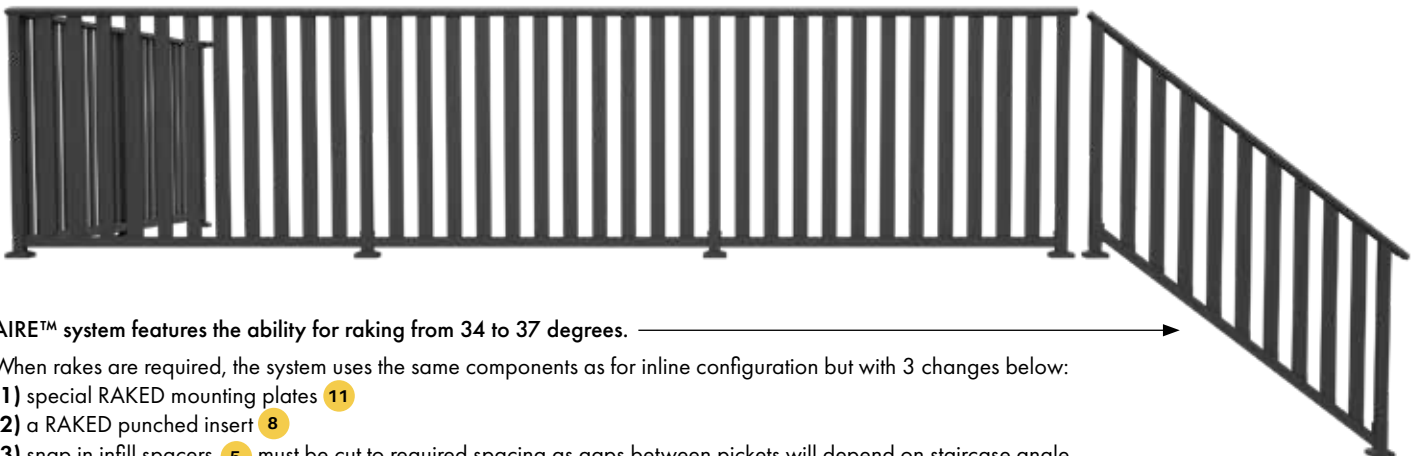

AIRE™ system features the ability for raking from 34 to 37 degrees. →

When rakes are required, the system uses the same components as for inline configuration but with 3 changes below:

- (1) special RAKED mounting plates **11**
- (2) a RAKED punched insert **8**
- (3) snap in infill spacers **5** must be cut to required spacing as gaps between pickets will depend on staircase angle.

These 3 items are available as stock items.

For the top of posts, simply cut at required angle and then screw fix on undercapping rail **2**

AIRE™

- 1 **75x30mm top rail**
(available oval or rectangle profile)
- 2 **Undercapping rail**
- 3 **75x30mm end cap**
(available to suit oval or rectangle profile)
- 4 **10gx16mm fixing screw for end cap**
- 5 **Snap in spacers**
- 6 **12gx20mm hex flange self drilling screw**
- 7 **65x16.5mm slat balusters**
- 8 **Punched insert (64mm gap spacing)**
- 9 **45x45mm bottom rail**
(also used as midrail for 3 rail installations)
- 10 **12gx25mm screws for:**
1) Fixing rail mounting plates to posts
(* for fixing to aluminium posts. Use different/appropriate screws if fixing to timber/steel etc)
2) Bottom rail locking screen
3) Fixing undercapping rail to posts
- 11 **Mounting plates**
- 12 **12gx50mm screws for fixing mounting plates to bottom rail**
- 13 **50x50 AIRE™ post**
(core drill, welded base plate or face mount posts)
- 14 **2 part domical cover**
(* if using base plated posts; use dress ring if core drill post)

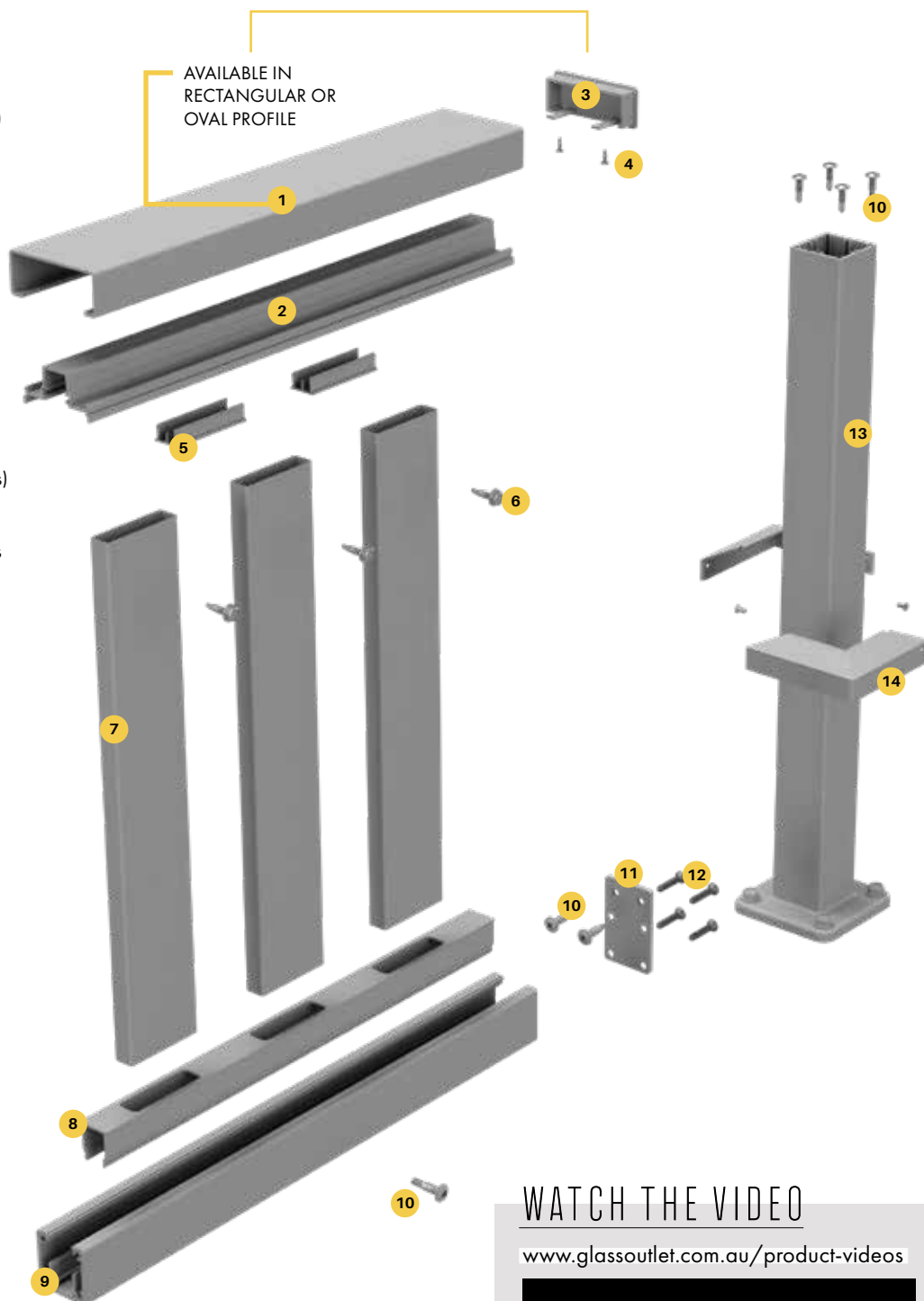

WATCH THE VIDEO

www.glassoutlet.com.au/product-videos





AIRE™



STEP 1

Screw fix first picket ensuring straight and in correct position.



STEP 2

Insert balance of pickets and snap in spacers. Do not screw fix remaining pickets yet. Ensure all pickets and spacing true and correct.



STEP 3

Screw fix each picket with spacers in position.



NOTE – Select finish code:
(EG AR-1050-FPBP-B for black)



BLACK



MONUMENT



WHITE



MILL

Order Code	Description	Colours
AR-1050-FPBP-B/M/MN/W	1050mm high – 50x50mm post with welded on 100x100mm base plate	
AR-5800-FP-B/M/MN/W	5800mm long – 50x50mmx3.2mm full post	
AR-1500-FMID-B/M/MN/W	1500mm long – 50x50x4mm MID post with welded on 150x150 face mounting plate	
AR-1500-FMLR-B/M/MN/W-2PK	1500mm long – 50x50x4mm END posts with welded on 160x150 face mounting plates – LEFT & RIGHT	
A50-1400D-HALF-B/M/MN/W	1400mm long – 50x25x3mm half post	
A50-5800D-HALF-B/M/MN/W	5800mm long – 50x25x3mm half post	
A50-1400-INF-B/M/MN/W	1400mm long – 21x12mm infill	
AR-5600-PB-B/M/MN/W	5600mm long – 16.5 x 16.5 x 1.4mm baluster	
XP-6100-S65-B/M/MN/W	6100mm long – 65 x 16.5mm slot baluster	
AW-5800-S65-KWI/WRC	5800mm long – 65 x 16.5mm slot baluster – timber image finish	
A50-5800-RHR-B/M/MN/W	5800mm long rectangular handrail with undercapping rail	
A50-5800-OHR-B/M/MN/W	5800mm long oval handrail with undercapping rail	
AR-5800-BR-B/M/MN/W	5800mm long – Bottom rail	
AR-3250-INS-16-B/M/MN/W	3250mm long – Bottom rail insert for 16.5mm square pickets	
AR-3214-INS-16RA-B/M/MN/W	3214mm long – Raked bottom rail insert for 16.5mm square pickets	
AR-3022-INS-65-B/M/MN/W	3022mm long – Bottom rail insert for 65 x 16.5mm vertical slat	
AR-3175-INS-65RA-B/M/MN/W	3175mm long – Raked bottom rail insert for 65 x 16.5mm vertical slat	
AR-SPACER-93MM-B/M/MN/W	93mm wide top spacer for 16.5 x 16.5mm picket balustrade	
AR-SPACER-65MM-B/M/MN/W	65mm wide top spacer for 65 x 16.5mm vertical slat balustrade	
A50-1400-INF-B/M/MN/W	1400mm long aluminium infill/spacer	
AR-PLATE-B/M/MN/W-2PK	Mounting plate for bottom rail – 2 pack	
AR-RK-PLATE-B/M/MN/W-2PK	Mounting plate for bottom rail (Raked) – 2 pack	
A50-ECA-R-B/M/MN/W	75 x 30mm rectangular end cap	
A50-BRACKET-R-B/M/MN/W-2PK	143 x 35mm rectangular handrail offset bracket	
A50-ECA-O-B/M/MN/W	75 x 30mm oval end cap	
A50-BRACKET-O-B/M/MN/W-2PK	142 x 35mm oval handrail offset bracket	
A50-WP-B/M/MN/W	Wall plate (attaches to undercapping rail)	
XP-DC-2P-B/M/MN/W	106 x 106mm two part domical cover	
XP-DR-B/M/MN/W	100 x 100mm dress ring	
SS-TS-50-SS304	12g x 20mm picket/baluster screw with square drive head – 50 pack	
AR-SCR-BR-50PK/B/W	12g x 25mm panhead screw with square drive head – 50 pack	
XP-SCREWS-B/M/MN/W	Self drilling wafer screws – 100 pack	
CSK-12GX50-50PK	12g x 50mm long countersunk screws – 50 pack	
DB-PH3	Phillips #3 driver bit	
DB-SQ3.4	Square head driver bit	
PAINT-B/MN/W	Touch up paint	

HORIZONTAL SLAT BALUSTRADE

Why choose horizontal slat balustrade?

AIRE™ Horizontal Slat Balustrade is a complete non-weld system which perfectly typifies the saying 'simplicity is the ultimate form of sophistication'. With sleek lines and innovative design consideration ensuring screw fixings are hidden, the system is easy to install and yet provides for a stunning finish.

The system is stocked in 3 popular powder coat finishes – satin black, monument matt and pearl white glass. It is also available in mill finish allowing customisation of powder coat colour. Pre-powder coated material can be cut to required lengths and assembled onsite. The installation process is simple and effective – side frames are affixed to the sturdy aluminium posts and 65mm horizontal slats are screw fixed at 9mm spacings either side with a fixing cover hiding screws.

The system has been extensively load tested by accredited NATA testing facilities. Importantly, engineering compliance certification is available.

Certification

Certificate of Compliance to load test requirements of AS/NZS 1170.0, AS/NZS 1170.1 and NCC2022. Contact us for engineering information.



STYLES OF HORIZONTAL SLAT BALUSTRADE

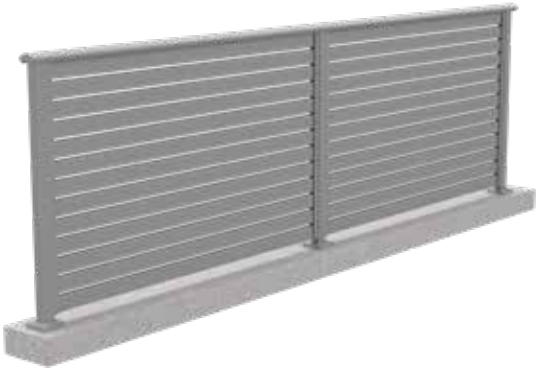

01 Horizontal Slat Balustrade

Horizontal 65mm slat balustrade with 9mm spacing with welded on base plated posts

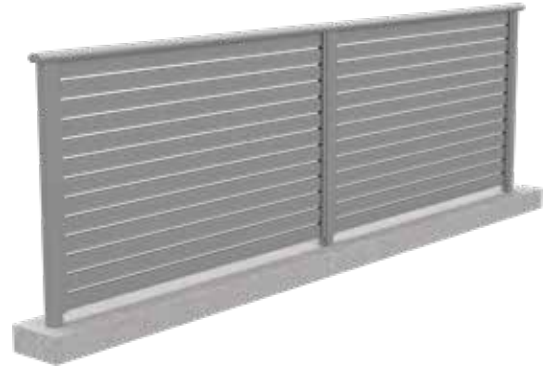

02 Horizontal Slat Balustrade

Horizontal 65mm slat balustrade with 9mm spacing with core drill posts

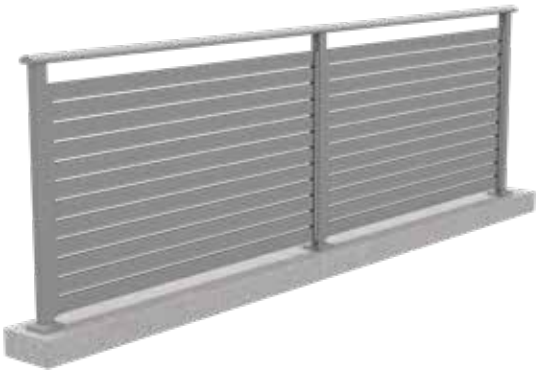

03 Horizontal Slat Balustrade

Horizontal 65mm slat balustrade with 9mm spacing with visibility gap and welded on base plated posts

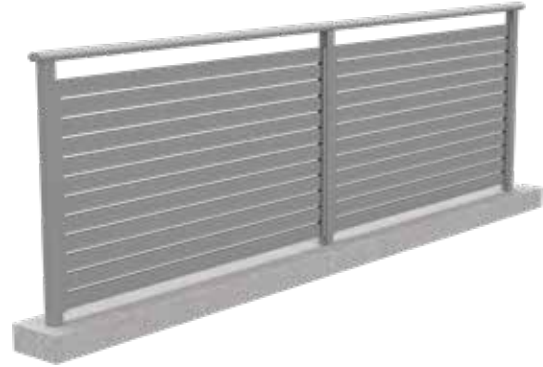

04 Horizontal Slat Balustrade

Horizontal 65mm slat balustrade with 9mm spacing with visibility gap and core drill posts

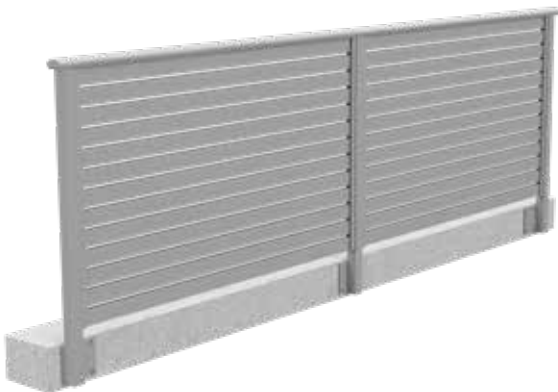

05 Horizontal Slat Face Mount

Horizontal 65mm slat balustrade with 9mm spacing and face mounted

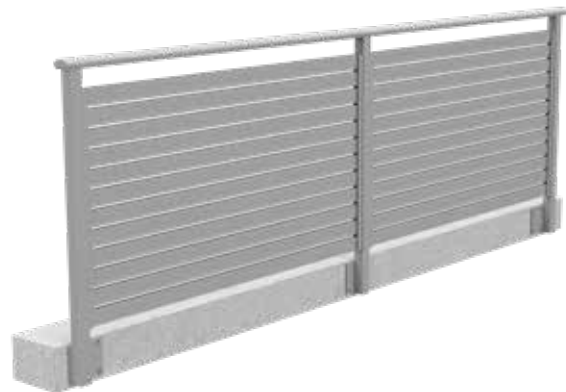

06 Horizontal Slat Face Mount

Horizontal 65mm slat balustrade with 9mm spacing with visibility gap and face mounted

HORIZONTAL SLAT BALUSTRADE

- 1 75x30mm top rail**
(available oval or rectangle profile)
- 2 Undercapping rail**
- 3 75x30mm end cap**
(available to suit oval or rectangle profile)
- 4 Snap in infill**
(into undercapping void for neat finish)
- 5 65x16.5mm horizontal slat balusters**
- 6 25x26mm Side frame** (fixes to post)
- 7 25x11 mm Fixing cover**
- 8 10g x 16mm wafer SS304 screws**
(various applications)
- 9 12g x 25mm screws**
(for fixing undercapping rail to posts)
- 10 50x50 aluminium post**
(core drill, welded base plate or face mount posts)
- 11 2 part domical cover**
(** if using base plated posts; use a dress ring if core drill post)

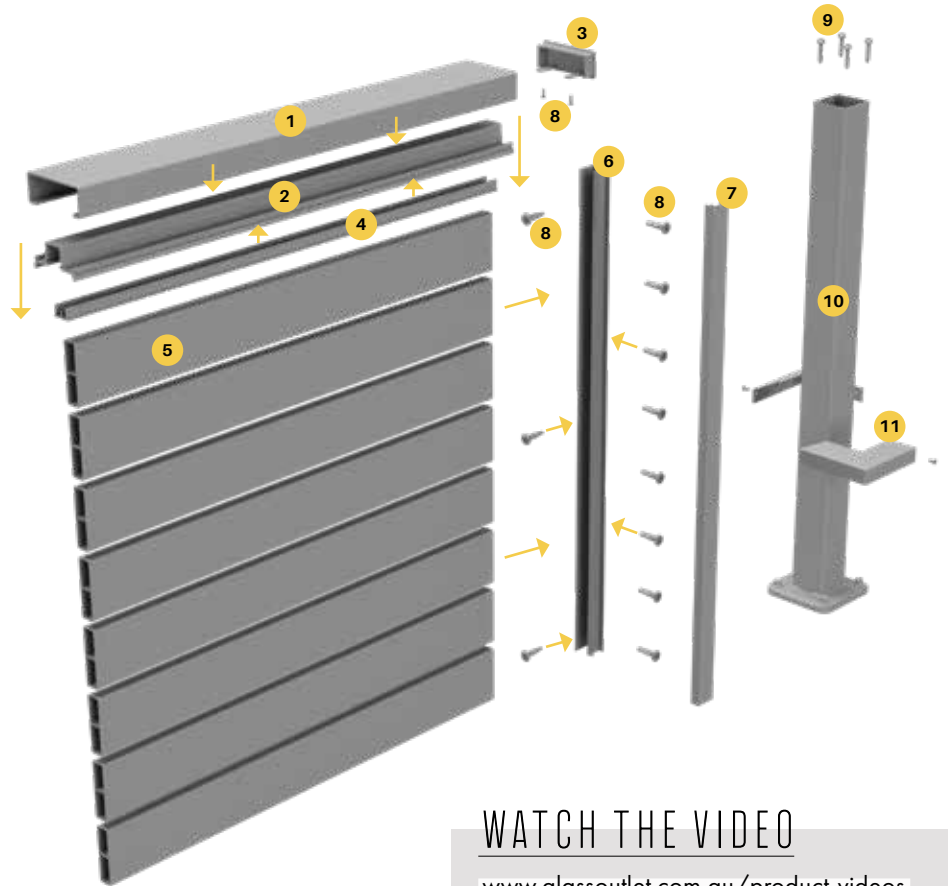

WATCH THE VIDEO

www.glassoutlet.com.au/product-videos

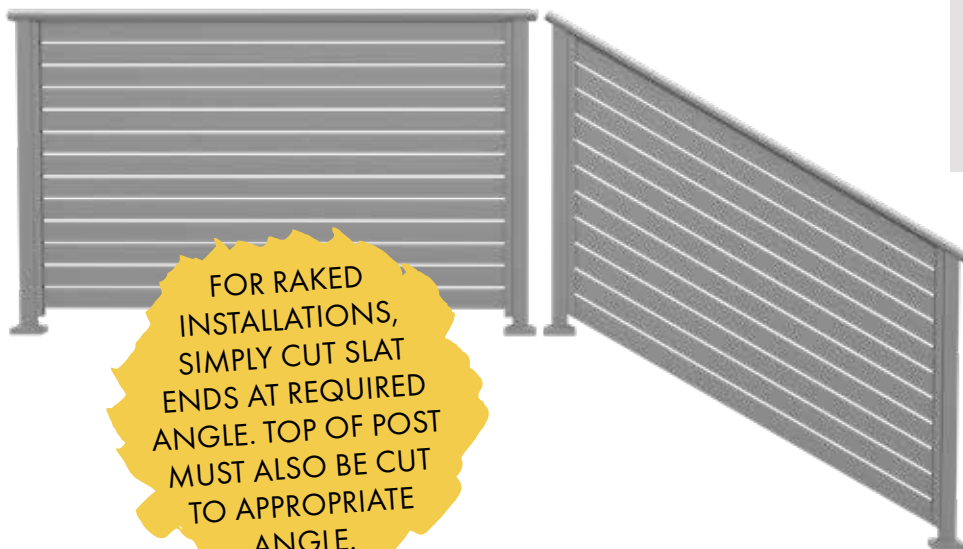

FOR RAKED
INSTALLATIONS,
SIMPLY CUT SLAT
ENDS AT REQUIRED
ANGLE. TOP OF POST
MUST ALSO BE CUT
TO APPROPRIATE
ANGLE.

FINISHES

Our colour range

AIRE™ horizontal slat balustrade is stocked in 3 popular balustrade powder coat finishes: Satin Black, Monument Matt and Pearl White Gloss. Mill finish is also available enabling customisation to any desired powder coat finish.

Satin black and monument matt continue to be the consistent colour palate for balustrade and seamlessly integrate into a variety of backgrounds. Pearl White is a growing trend in balustrade with the proliferation of Hamptons inspired design.

Genuine Interpon powder is used with Interpon D1000 manufacturer warranties provided.

AIRE™ horizontal slat balustrade extrusions are produced to the chemical composition, mechanical property and dimensional tolerances in AS-NZS 1866:1997

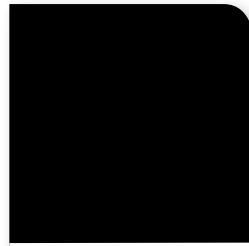

SATIN BLACK
GN150A (B)

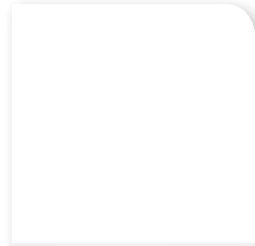

PEARL WHITE GLOSS
GA078A (W)



MONUMENT MATT
GL229A (MN)



MILL (M)
Ready to powder coat



NOTE – Select finish code:
(EG AR-1050-FPBP-B for black)

ORDER CODES

Order Code	Description	Colours
AR-1050-FPBP-B/M/MN/W	1050mm high – 50x50mm post with welded on 100x100mm base plate	
AR-5800-FP-B/M/MN/W	5800mm long – 50x50mmx3.2mm full post	
AR-1500-FMID-B/M/MN/W	1500mm long – 50x50x4mm MID post with welded on 150x150 face mounting plate	
AR-1500-FMLR-B/M/MN/W-2PK	1500mm long – 50x50x4mm END posts with welded on 160x150 face mounting plates – LEFT & RIGHT	
A50-1400D-HALF-B/M/MN/W	1400mm long – 50x25x3mm half post	
A50-5800D-HALF-B/M/MN/W	5800mm long – 50x25x3mm half post	
XP-6100-S65-B/M/MN/W	6100mm long – 65 x 16.5mm slat baluster (with centre web)	
AW-5800-S65-KWI/WRC	5800mm long – 65 x 16.5mm slat baluster (with centre web) – timber image finish	
QS-5800-SF-B/M/MN/W	5800mm long – 25x26mm Quickscreen side frame	
QS-5800-CFC-B/M/MN/W	5800mm long – 25x11mm Quickscreen concealed fixing cover	
A50-5800-RHR-B/M/MN/W	5800mm long rectangular handrail with undercapping rail	
A50-5800-OHR-B/M/MN/W	5800mm long oval handrail with undercapping rail	
A50-1400-INF-B/M/MN/W	1400mm long aluminium infill	
A50-ECA-R-B/M/MN/W	75 x 30mm rectangular end cap	
A50-BRACKET-R-B/M/MN/W-2PK	143 x 35mm rectangular handrail offset bracket	
A50-ECA-O-B/M/MN/W	75 x 30mm oval end cap	
A50-BRACKET-O-B/M/MN/W-2PK	142 x 35mm oval handrail offset bracket	
A50-WP-B/M/MN/W	Wall plate (attaches to undercapping rail)	
XP-DC-2P-B/M/MN/W	106 x 106mm two part domical cover	
XP-DR-B/M/MN/W	100 x 100mm dress ring	
PP-SCREW-B/MN	10g x 16mm SS304 self drilling wafer screw – 50 pack	
XP-SCREW-W	10g x 16mm zinc self drilling wafer screw – 100 pack	
AR-SCR-BR-50PK	12g x 25mm SS304 panhead screw with square drive head – 50 pack	
S-110LAG-4PK	M10 x 110mm SS316 long timber lag screw – 4 pack	
S-120ROD-4PK	M10 x 120mm thread rod with nuts/washers – 4 pack	
DB-PH3	Phillips #3 driver bit	
DB-SQ3.4	Square head driver bit	
PAINT-B/MN/W	Touch up paint	

BLACK
 MONUMENT
 WHITE
 MILL
 KWILA
 WESTERN RED CEDAR



STYLES OF PREMIUM PERF BALUSTRADE

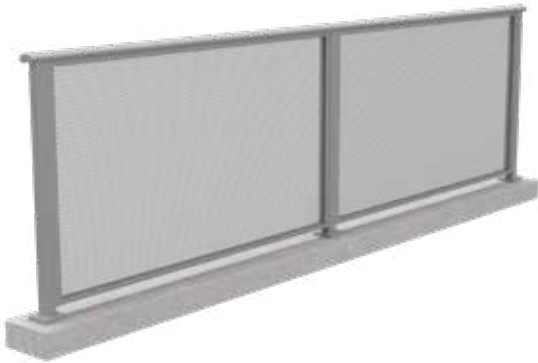

01 Perf Balustrade
Full perf panel with welded base plated posts

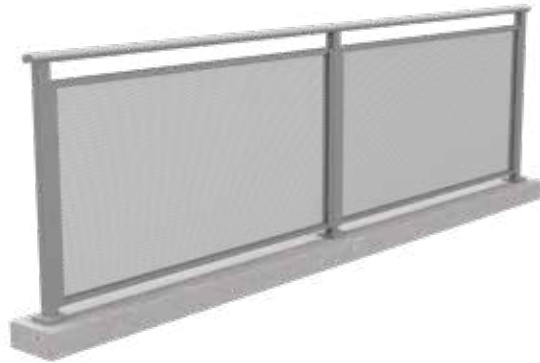

02 Perf Balustrade
Perf with visibility gap and welded base plated posts

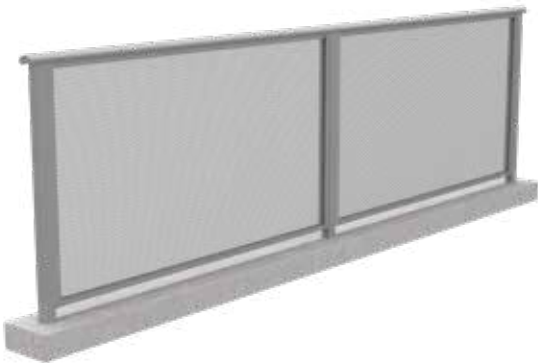

03 Perf Balustrade
Full perf panel with core drilled posts

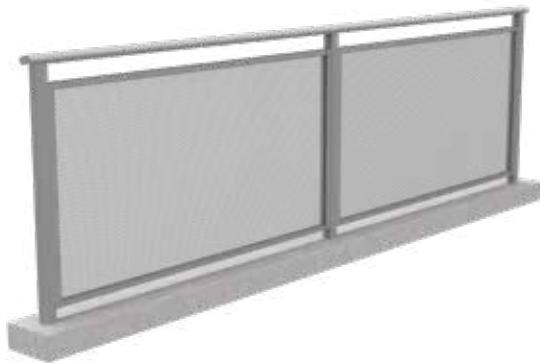

04 Perf Balustrade
Perf with visibility gap and core drilled posts

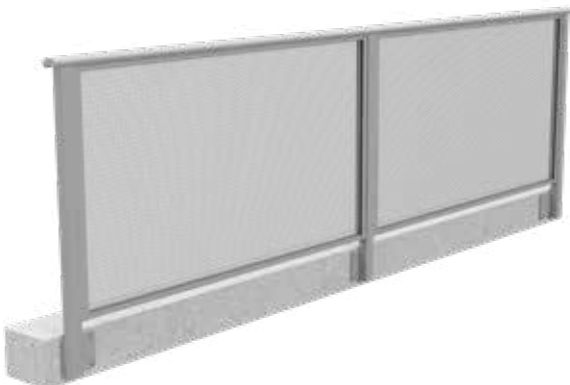

05 Perf Face Mount
Full perf panel with face mount

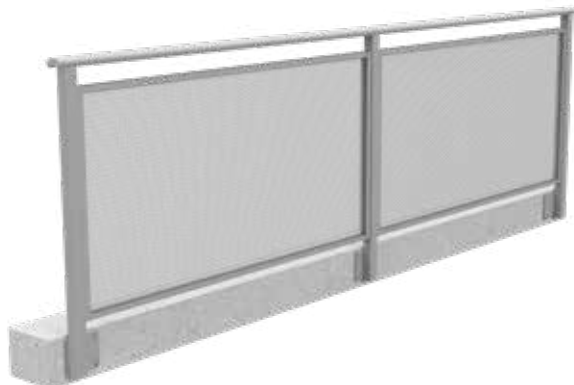

06 Perf Face Mount
Perf with visibility gap with face mount

PREMIUM PERF BALUSTRADE

- 1 **75x30mm top rail**
(available oval or rectangle profile)
- 2 **Undercapping rail**
- 3 **75x30mm end cap**
(available to suit oval or rectangle profile)
- 4 **10g x 16mm wafer SS304 screws**
(used for various fixing applications)
- 5 **12gx25mm screws for fixing undercapping to posts**
- 6 **Perforated infill panel**
- 7 **38x25mm framing for infill panel**
- 8 **Snap-bead to suit 38x25mm framing**
- 9 **U channel**
(into which 38x25mm frame fits inside)
- 10 **50x50 aluminium post**
(core drill, welded base plate or face mount posts)
- 11 **2 part domical cover**
(** if using base plated posts; use a dress ring if core drill post)

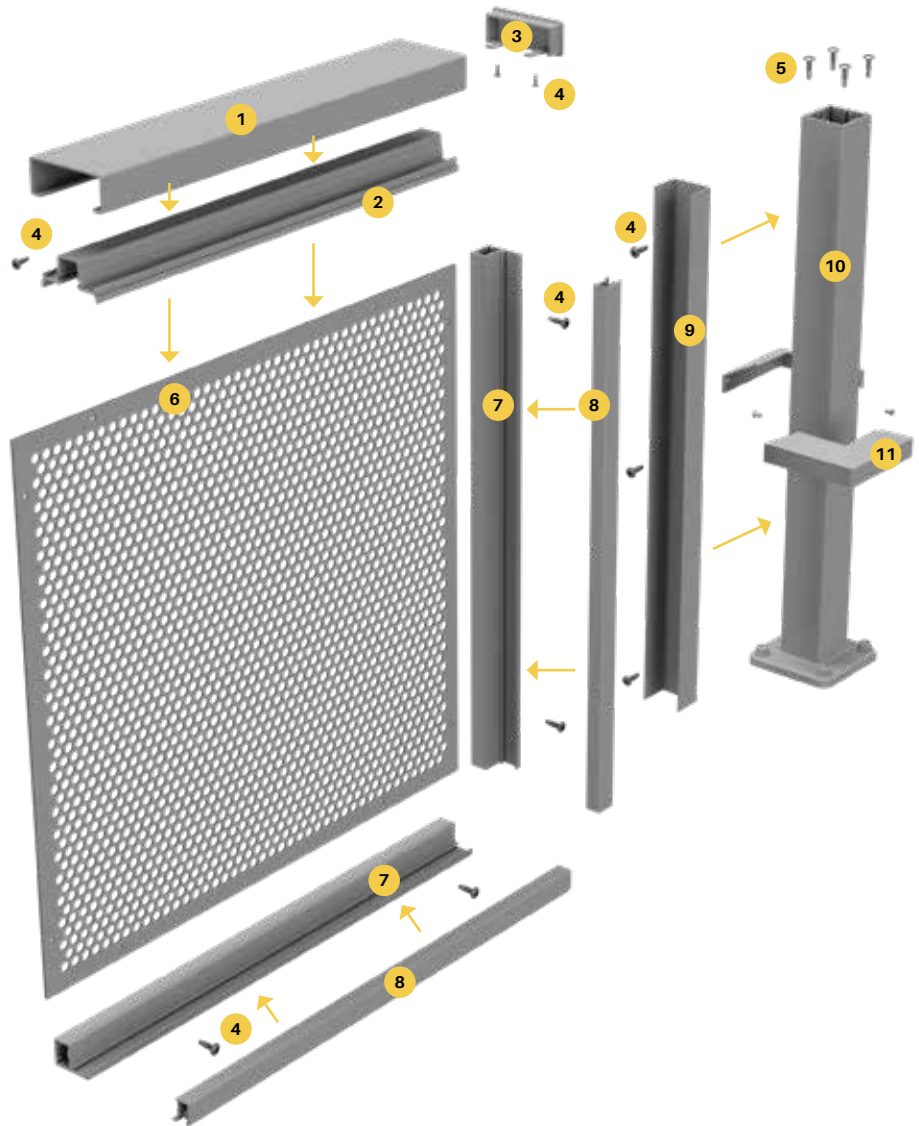

FINISHES

Our colour range

Premium Perf Balustrade is stocked in 2 popular powder coat finishes being Satin Black and Monument.

For Satin Black, posts and framing is Interpon Satin Black GN150A finish with the perforated infill panel being Textura black finish.

For Monument Matt posts and framing is Interpon Monument Matt GL229A finish with the perforated infill panel being Textura monument finish.

Genuine Akzo Nobel/Interpon powder is used with Interpon D1000 manufacturer warranties provided.

Extrusions are produced to the chemical composition, mechanical properties and dimensional tolerances of AS-NZS 1866-1997.

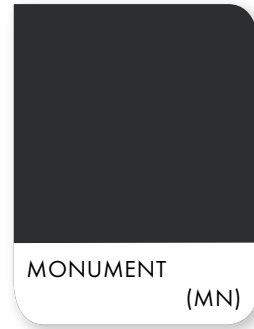
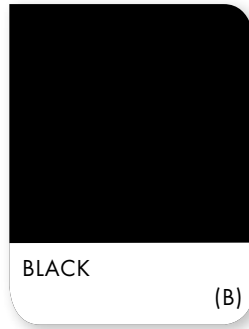



NOTE – Select finish code:
(EG AR-1050-FPBP-B for black)

ORDER CODES



Order Code	Description	Colours
AR-1050-FPBP-B/MN	1050mm high – 50x50mm post with weld on 100x100mm base plate	 
AR-5800-FP-B/MN	5800mm long – 50x50mmx3.2mm full post	 
AR-1500-FMID-B/MN	1500mm long – 50x50x4mm MID post with welded on 150x150 face mounting plate	 
AR-1500-FMLR-B/MN-2PK	1500mm long – 50x50x4mm END posts with welded on 160x150 face mounting plates – LEFT & RIGHT	 
A50-1400D-HALF-B/MN	1400mm long – 50x25x3mm half post	 
A50-5800D-HALF-B/MN	5800mm long – 50x25x3mm half post	 
A50-1400-INF-B/MN	1400mm long – 21x12mm infill	 
A50-5800-RHR-B/MN	5800mm long rectangular handrail with undercapping rail	 
A50-5800-OHR-B/MN	5800mm long oval handrail with undercapping rail	 
PP-BAL-INFILL-B/MN	1726mm wide x 988mm perforated infill panel	 
PP-BAL-FRAMEKIT-B/MN	38x25mm 2 part frame kit (includes complete panel frame & U channel)	 
A50-ECA-R-B/MN	75 x 30mm rectangular end cap	 
A50-BRACKET-R-B/MN-2PK	143 x 35mm rectangular handrail offset bracket	 
A50-ECA-O-B/MN	75 x 30mm oval end cap	 
A50-BRACKET-O-B/MN-2PK	142 x 35mm oval handrail offset bracket	 
A50-WP-B/MN	Wall plate (attaches to undercapping rail)	 
XP-DC-2P-B/MN	106 x 106mm two part domical cover	 
XP-DR-B/MN	100 x 100mm dress ring	 
PP-SCREW-B/MN	10gx16mm self drilling wafer screw – 50 pack	 
AR-SCR-BR-50PK	12g x 25mm panhead screw with square drive head – 50 pack	
S-110LAG-4PK	M10 x 110mm long timber lag screw – 4 pack	
S-120ROD-4PK	M10 x 120mm thread rod with nuts/washers – 4 pack	
DB-PH3	Phillips #3 driver bit	
DB-SQ3.4	Square head driver bit	
PAINT-B/MN	Touch up paint	 

