

BLITZ GLASS

Balustrading Breezewire



www.blitzglass.com.au



(07) 5493 9779



admin@blitzglass.com.au

BLITZ GLASS

3

The highest quality electropolished SS316 wire

Wire balustrade provides a modern and stylish finish which may be installed stand alone or in combination with timber posts/handrail or glass. We offer everything you need to create a stunning stainless steel wire balustrade.



Produced by a single manufacturer with 25 years of production excellence. Consistency of quality assured.



Electropolish process improves corrosion resistance and provides a shiny and smooth surface.



Extra ultrasonic washing step ensures the brightest wire finish.

WIRE OPTIONS

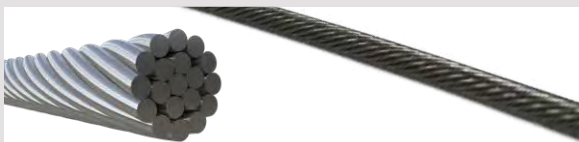

1x19 Stainless steel wire

3.2MM - GRADE SS316

Available in 100m or 305m rolls

Code: BW-S1193.2-100 (100m roll)

BW-S1193.2-305 (305m roll)

- 19 individual wires woven into a single strand
- Electropolish superior shiny and smooth surface
- High resistance to tea staining
- Rigid wire with minimal stretch - ideal for straight runs
- Fittings at ends of wire should be swaged on - swageless fittings can also be used



Cut to size service also available
Simply provide opening sizes

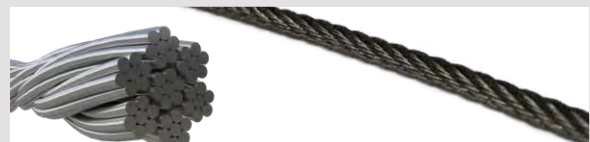

7x7 Stainless steel wire

3.2MM - GRADE SS316

Available in 100m or 305m rolls

Code: BW-S773.2-100 (100m roll)

BW-S773.2-305 (305m roll)

- 49 strands of wire woven into a single strand
- Electropolish superior shiny and smooth surface
- Semi-flexible wire suitable for swaging or for use with thimble and ferrules (hand swaging)

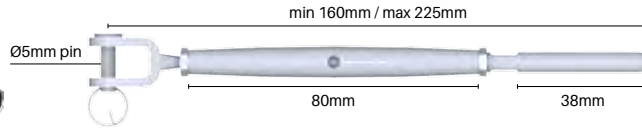

Rigging screw

SS316

Code: BW-RSM5-3.2

- Jaw swage - rotate body to tighten wire
- M5 x 3.2mm (with locking nut)
- Use with eye screws, lag screws or saddles
- Swage to wire using hydraulic press
- In-house hydraulic swaging service available



Ideal for stairs/angled installs as fitting can pivot on pin

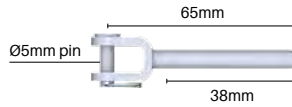

Fork terminal

SS316

Code: BW-FTM5-3.2

- Fork terminal swage
- M5 x 3.2mm
- Use with eye screws, lag screws or saddles
- Swage to wire using hydraulic press
- In-house hydraulic swaging service available



Ideal for stairs/angled installs as fitting can pivot on pin



SWAGELESS

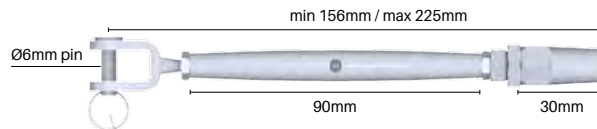

Swageless rigging screw

SS316

Code: BW-RSM6-SLESS

- Jaw and swageless - No specialised tools required
- M6 x 3.2mm (with locking nut)
- Simply push in wire and rotate gripping terminal body to tighten - quick and easy assembly
- Use with eye screws, lag screws or saddles



Ideal for stairs/angled installs as fitting can pivot on pin



SWAGELESS

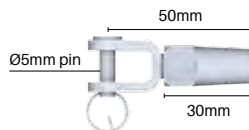

Swageless fork terminal

SS316

Code: BW-FT-SLESS

- Swageless - No specialised tools required
- Suits 3.2mm wire
- Simply push in wire and rotate gripping terminal body to tighten - quick and easy assembly
- Use with eye screws, lag screws or saddles



Ideal for stairs/angled installs as fitting can pivot on pin

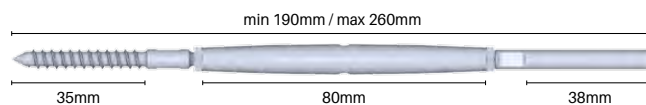

Lag rigging screw

SS316

Code: BW-RSLAG-3.2

- Lag screw threaded rigging screw - provides slimline finish
- Rotate body to tighten wire
- M5 x 3.2mm (with locking nut) with an M6 lag screw
- Suitable for installation into timber
- Swage to wire using hydraulic press
- In-house hydraulic swaging service available
- Suggested to use with **BW-M6LST-L** at other end

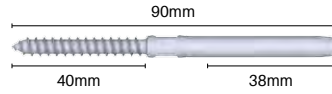

Lag threaded terminal SS316

Code: BW-M6LST-L/R (Left/Right)

- Lag screw swage - Left & right hand available - provides slimline finish
- M6 x 3.2mm
- Left and right required to complete system
- Tighten by turning terminal with spanner
- Suitable for installation into timber
- Swage to wire using hydraulic press
- In-house hydraulic swaging service available

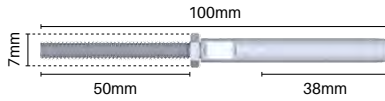

Threaded terminal SS316

Code: BW-TTM6-3.2-L/R (Left/Right)

- Swage stud - Left & right hand available - provides slimline finish
- M6 x 3.2mm (with locking nut)
- Threads into M6 blind rivet nut or M6 tapped post
- Tighten by turning terminal with spanner
- Swage to wire using hydraulic press
- In-house hydraulic swaging service available



Can be used with pre-tapped posts. A left and right post is required
Use with hex tensioner

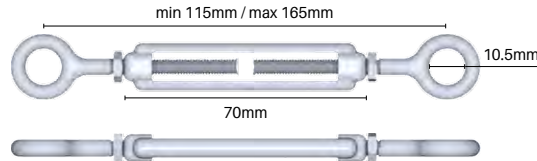

Eye to eye turnbuckle SS316

Code: BW-TBM5-EE

- Turnbuckle open body
- M5 - Eye to eye (with locking nuts)
- Tighten wire by turning body of fitting
- Use with thimble and ferrules or wire rope grip
- Commonly used with 7x7 wire due to wire flexibility required

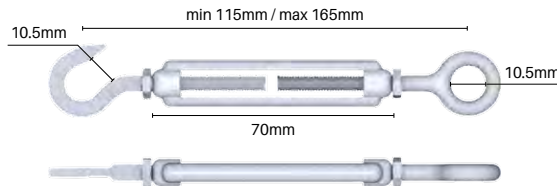
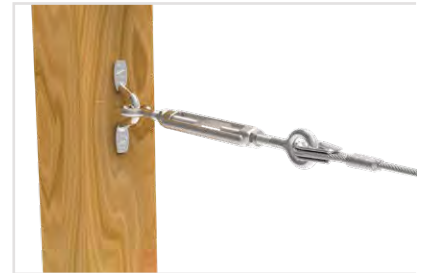

Hook to eye turnbuckle SS316

Code: BW-TBM5-HE

- Turnbuckle open body
- M5 - Hook to eye (with locking nut)
- Tighten wire by turning body of fitting
- Use with thimble and ferrules or wire rope grip
- Commonly used with 7x7 wire due to wire flexibility required
- Hook end enables easy install - simply hook onto end fitting

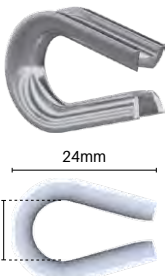

3.2mm thimble SS316

Code: BW-TH-3.2

- Use with 7x7 wire and ferrule for hand swaging
- Simple installation - swage onsite with hand tool
- Thimble commonly used with eye screws or saddles for end fixings



3.2mm ferrule

NICKLE PLATED COPPER

Code: BW-FER-3.2

- Use in conjunction with 7x7 wire and thimble
- Use hand swage tool to clamp swage sleeves



Code: BW-HST

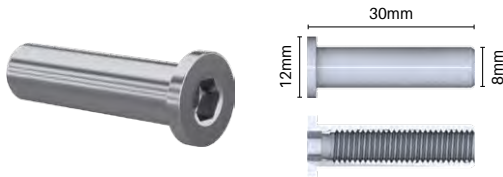

Allen key hex tensioner SS316

Code: **BW-HEXTEN-M6**

- M6 internal right hand thread
- Use with M6 threaded terminal (BW-TTM6-3.2-R)
- Tighten wire by turning allen key head - wire must be swaged



Drill through post both sides then fit hex tensioner with threaded terminal through hole - hex tensioner head rests on outside wall of post for a neat finish

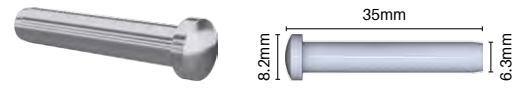

Dome head terminal SS316

Code: **BW-DHT-3.2**

- Swage terminal onto 3.2mm wire
- Commonly used at opposite end of a hex tensioner installation
- Head of dome terminal rests on outside wall of post
- Provides slimline finish

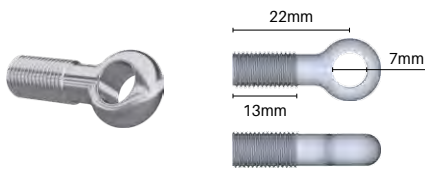

Eye screw SS316

Code: **BW-M6X10-ES**

- M6 eye screw
- Use with M6 blind rivet nut (right thread only) or M6 tapped posts (right threaded)
- Suits screwing into pre-tapped SS316 base plated posts
- Ideal for staircase/angled installs in conjunction with rigging screws/fork terminals - terminals can swivel to required angle easily

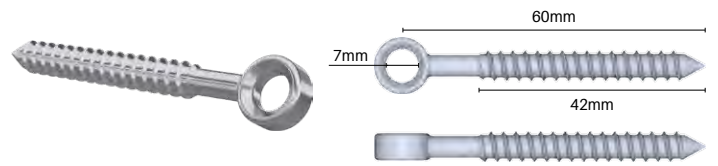

Lag eye screw SS316

Code: **BW-M6X60-LS**

- M6 lag eye screw
- Suitable for fixing to timber
- Ideal for staircase/angled installs in conjunction with rigging screws/fork terminals - terminals can swivel to required angle easily

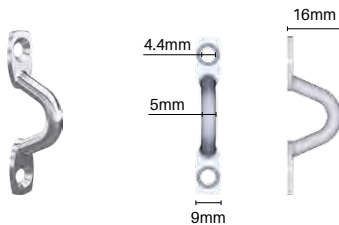

5mm saddle SS316

Code: **BW-M5-SAD**

- M5 saddle
- Versatile end fitting - affix to timber or steel/aluminium
- Ideal for staircase/angled installs in conjunction with rigging screws/fork terminals - terminals can swivel to required angle easily



Also suitable for fixing to metal

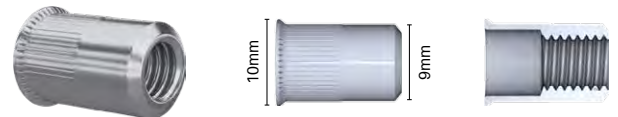

Blind rivet nut SS304

Code: **BW-M6RIVNUT-L/R (Left/Right)**

- M6 - Left & right threaded available
- Also referred to as a nutsert
- Install with rivet nut hand tool
- Suitable for metal posts - drill hole size: Ø9mm
- Commonly used with eye screws or threaded terminals



Wire rope grip

SS316

Code: **BW-WG-3.2**

- Suits 3.2mm wire
- Clamping action holds wire in place

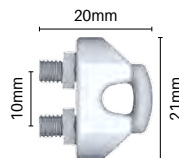

Split nylon grommet

Code: **BW-SNG-B/G (Black/Grey)**

- Available in UV stabilised black or grey
 - Should always be used when wire passes through steel or aluminium posts
 - Drill hole size: 9mm
 - Use to prevent electrolysis or chafing by separating stainless steel wire from touching metal or aluminium
 - *Black grommets also available in a pack of 20
- Use order code: **RBW-SNG-B-20PK**

Trellis kits

Code: **BWR-TK-2.5/5/10 (2.5m/5m/10m kit)**

- 1x turnbuckle hook & eye, 2x lag eye screws, 2x grips & wire and 2x saddles
- Available in 2.5mt, 5mt, and 10mt kits
- Use to grow vines or vertical gardens - a great solution for creating green spaces



BREEZEWIRE POST KITS

A range of SS316 high polish pre-drilled posts & spreader posts.

Our post kits enable a professional and fast installation with huge cost savings with pre-drilled and tapped holes.

FOR END/CORNER POSTS: Simply screw in eye screws or threaded terminals
FOR MID POSTS: Hole spacing matches end/corner posts for easy installation

SPECIFICATION

982mm high round post with pre-welded base plate

SS316 in high polish #800 finish

11 x drilled and tapped M6 holes allow for M6 threaded fixings to be screwed into post (mid post holes are not tapped)

KIT CONTENTS

1 x 50.8mm round post with 11 x drilled and tapped M6 holes with pre-welded base plate - 2.7mm wall thickness (mid post holes are not tapped and mid post wall thickness is 1.5mm)

1 x domical cover

2 x saddles suitable for flat or 50.8mm round handrail



END POST 50.8mm drilled & tapped M6 base plated post

Code: BW-LEFTBP/RIGHTBP-P

- Ideal start/end post - left or right threaded
- 982mm high - 2.7mm wall thickness
- High polish finish
- 11 x runs of M6 threaded and tapped holes (81mm hole centres)
- 8mm thick countersunk base plate welded to post (100mm outer diameter)
- 1x flat and 1x 50.8mm curved saddle included - simply affix required saddle
- 1x domical cover included



90° POST 50.8mm drilled & tapped M6 base plated post

Code: BW-90BP-P

- Corner post - wire runs into post from 2 sides at 90°
- 982mm high - 2.7mm wall thickness
- High polish finish
- 11 x runs of M6 threaded and tapped holes at 90° (81mm hole centres) - all holes are right threaded
- 8mm thick countersunk base plate welded to post (100mm outer diameter)
- 1x flat and 1x 50.8mm curved saddle included - simply affix required saddle
- 1x domical cover included



MID POST 50.8mm drilled & base plated post

Code: BW-180BP-P

- Holes in posts allow wire to pass through - mid posts are ideal over longer spans to ensure wire spreads evenly and wire deflection is minimised
- 982mm high - 1.5mm wall thickness
- High polish finish
- 11 x runs of drilled holes at 180° (81mm hole centres)
- If using pre-swaged wire, holes must be drilled out to 7mm
- 8mm thick countersunk base plate welded to post (100mm outer diameter)
- 1x flat and 1x 50.8mm curved saddle included - simply affix required saddle
- 1x domical cover included

FITTINGS IDEAL FOR USE WITH START OR END POSTS



Threaded terminal SS316 - left or right

Code: BW-TTM6-3.2-L/R



Eye screw SS316

Code: BW-M6X10-ES

NOTE: Fittings are not required for mid posts.

TECHNICAL INFO

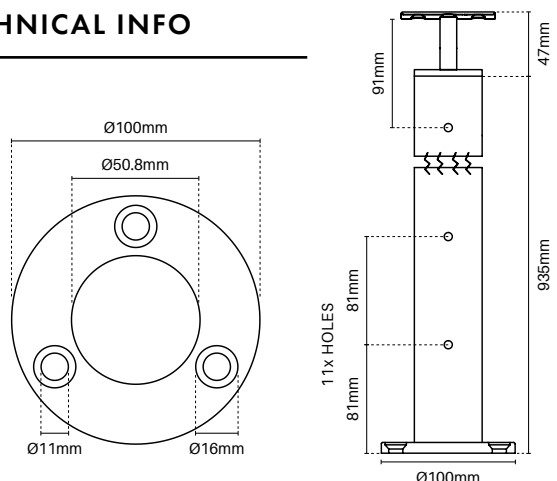

With longer runs of wire, an intermediate/spreader post is recommended to reduce wire deflection.

Our pre-drilled stainless steel 50x10mm posts are ideal for this situation. Depending on installation type, suitably drilled timber posts can also be used.

As a general guide, it is recommended that intermediate posts be used at 1200 centres. Each install situation is different and independent engineering advice should be sought.

All intermediate posts shown below are not structural/load supporting posts. They are designed as spreader posts to reduce wire deflection between structural posts/supports.



PRE-DRILLED 50x10mm intermediate post

972MM - SS316

Code: BW-5010-972D-BP-P

- 972mm high with 11 x pre-drilled Ø5mm holes at 81mm centres
- SS316 high polish
- Provides slimline finish with 10mm front on profile
- Hole centres match with Breezewire 50.8mm diameter end posts
- Welded base plate with 2x countersunk holes
- For top of post, choose from available optional extras dependent on top rail required



NO DRILL HOLES 50x10mm intermediate post

1000MM - SS316

Code: BW-5010-1000BP-P

- 1000mm high with no drill holes
- SS316 high polish
- Drill the holes as needed to suit install
- Height of post can be adjusted by cutting with a suitable blade
- Welded base plate with 2x countersunk holes
- For top of post, choose from available optional extras dependent on top rail required

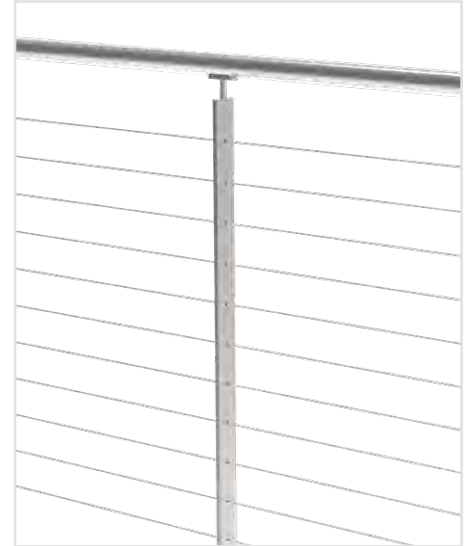

Adjustable top plate SS316

Code: BW-5010-AHP-P

- Grub screw clamps to top of 50x10 post
- Mechanical fix to post if required
- No welding required - easy post height adjustment with extended neck fitting
- 2x CSK holes - 2x grub screws

If using Breezewire pre-drilled & tapped start/end posts, use this fitting to achieve matching finished post heights



Round rail converter SS316

Code: BW-5010-RRC-P

- Suits 50x10 post - Fix to Ø50.8mm tube
- Tube can be neatly screwed/riveted from tags at side of fitting
- Mechanical fix to post if required

If using Breezewire pre-drilled & tapped start/end posts, use this fitting to achieve matching finished post heights

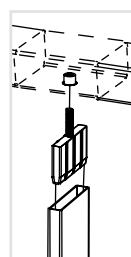
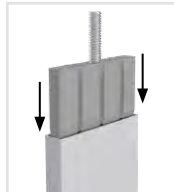

Flat rail converter SS316

Code: BW-5010-SRC

- Use to fix flat metal railing to 50x10mm intermediate post
- Provides a neat finish with hidden fixing
- Insert M6 nutsert into rail, screw flat rail converter into nutsert then drop into post

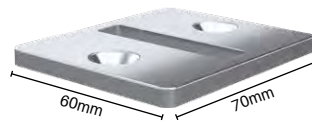

70x60mm base plate SS316

Code: BW-5010-BP-P

- 2x CSK holes
- Suits welding to 50x10mm tube

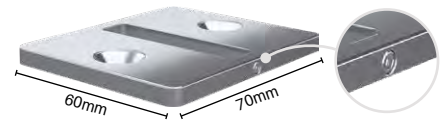

70x60mm top plate SS316

Code: BW-5010-TP-P

- Grub screw clamps to top of 50x10 post
- No welding required - easy post height adjustment
- 2x CSK holes - 2x grub screws



ADJUSTABLE HEIGHT



TOP

BOTTOM

Ø12mm slimline wire spreader post SS316

Code: BW-12D-1000D-BP-P

- 1000mm high with 11 x diam 5mm holes pre-drilled at 81mm centres
- SS316 high polish
- Slimline look with diam 12mm round profile tube
- Matches hole centres of Breezewire 50.8mm diameter end posts

- Innovative design gives maximum flexibility for installing
- Base plate fixed to tube with grub screws - Top plate suits 50.8mm tube and is clamped on with grub screws (Mechanical fix top/bottom plate if required)
- Height adjustable - simply cut Ø12mm tube to required length

MOD50 range Ø50.8mm posts

SS316 - HIGH POLISH FINISH

Codes: MOD50-1000-BP-P (Base plated)
 MOD50-1300-BP-P (Base plated)
 MOD50-1150-P (Core drill)
 MOD50-1400-P (Core drill)

- 1.5mm wall thickness
- Drill holes for wire as needed to suit install situation
- Commonly used for stairs where pass through holes are not inline
- Not recommended for start/end posts - use heavy duty 2.7mm wall thickness posts for start/end posts
- Height of post can be adjusted by simply cutting with suitable blade
- Welded base plate posts have 3 x countersunk holes
- For top of post, a swivel rail support is available or finish with end cap

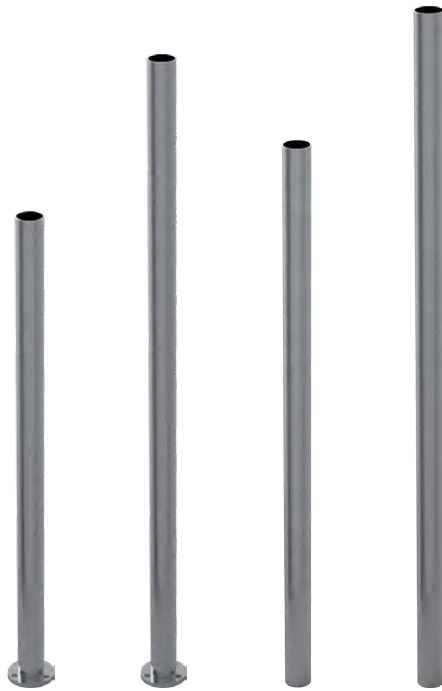

BASE PLATE SPECS

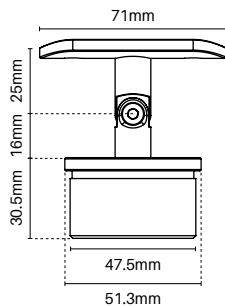
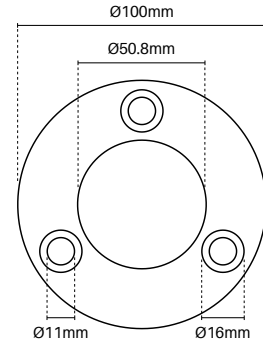

Swivel head rail support

SS316

Code: MOD50-BWSWIV-P

- Use with Ø50.8mm posts with 1.5mm wall thickness (not compatible for use with MOD50 heavy duty posts with 2.7mm wall thickness)
- Suits Ø50.8mm round or flat top rail
- Swivel fitting suits inline or stair installations
- Fittings drop into post - epoxy glue, weld or rivet fitting to post



Flat cap

SS316

Code: MOD50-ECF-P

- Easy to use tap-in fitting
- Suits 1.5mm wall thickness Ø50.8mm posts
- Epoxy glue, weld or drill/tap tube for joint strength



Domical cover

SS316

Code: BW-DC-P

- Raised domical cover
- Use with MOD50 Ø50.8mm round posts
- 23mm high



Dress ring

SS316

Code: MOD50-DR-P

- High polish finish
- Use with MOD50 Ø50.8mm round posts



SQ50 range 50x50mm posts

SS316 - HIGH POLISH FINISH

Codes: SQ50-1300-HDBP-P (Base plated)

SQ50-1400-HD-P (Core drill)

SQ50-5800S-5050-P (Core drill)

**HEAVY DUTY
SQUARE POST**
2mm WALL THICKNESS

- Core drill posts - 1400mm H / Base plated posts - 1300mm H
- Also available 5800mm long
- 2mm wall thickness
- Ideal start or end post option - use in conjunction with saddles or M6 nutserts - SQ50 posts can also be drilled both sides to be used as mid posts
- Top cap and domical cover included with base plated post - top cap included with 1400mm core drill post

BASE PLATE SPECS

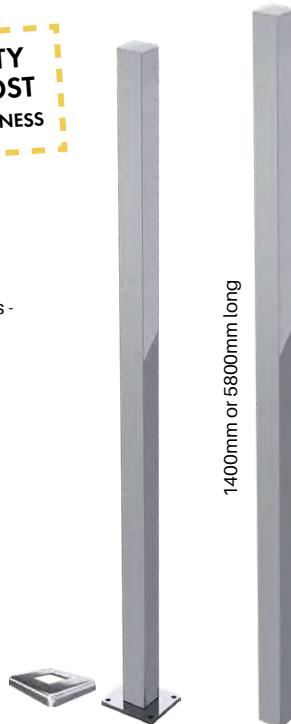
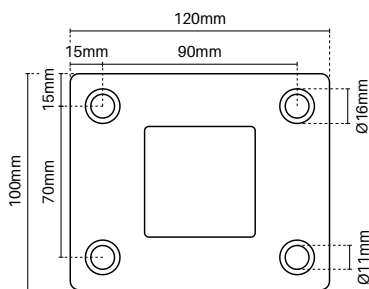

Flat dress ring

Code: SQ50-DR-P

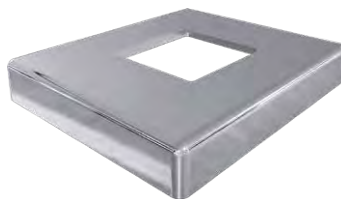

Domical cover

Code: SQ50-DC-P
16mm high cover



Base plate

Code: SQ50-BP-P
8mm thick



Installing Breezewire on a staircase?

The rigging screw and fork terminal can swivel to the exact angle needed.

Use rigging screw and fork terminal fittings with saddles or eye screws at each terminating end for quick and easy installation when working with tricky angles on staircases.

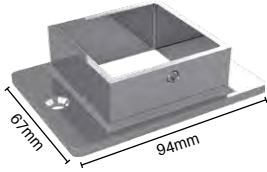

Oblong flange

SS316

Code: **SQ50-OBP-P**

- Use as a wall plate or use on top of posts to affix a flat handrail
- 25mm deep throat gives flexibility for install
- Internal grub screws hold square tube in place or mechanically fix/weld oblong flange to tube

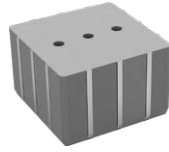

Internal perpendicular joiner

SS316

Code: **SQ50-IPD**

- Internal fitting holes used to screw/rievet to timber or metal handrail
- After affixing top rail to joiner, drop rail into 50.8mm x 50.8mm square posts
- Rivet internal joiner to post

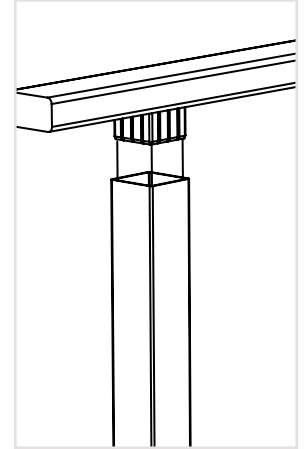
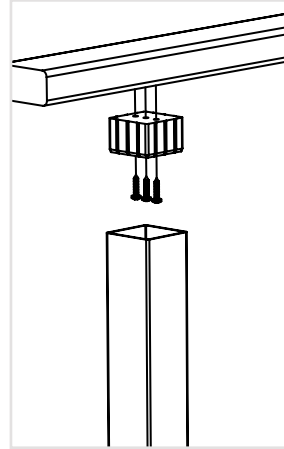

Inline rail joiner

SS316

Code: **SQ50-J-P**

- Use to join two lengths together discreetly
- Tube sleeves over and meets in the middle
- Weld or rivet to tube for secure fixing

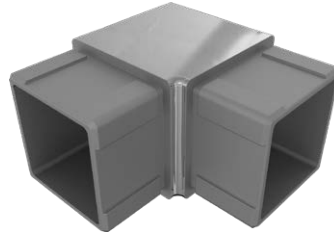

90 degree rail joiner

SS316

Code: **SQ50-J90-P**

- Ideal for a 90 degree corner
- Join two lengths together horizontally
- Weld or rivet to tube for secure fixing

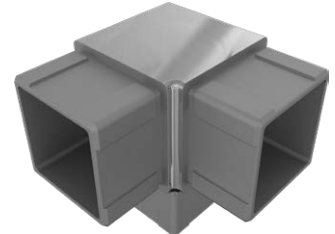

90 degree T rail joiner

SS316

Code: **SQ50-J90T-P**

- Ideal for a 90 degree horizontal corner joining to a vertical post. Three lengths connect on one joiner seamlessly
- Weld or rivet to tube for secure fixing

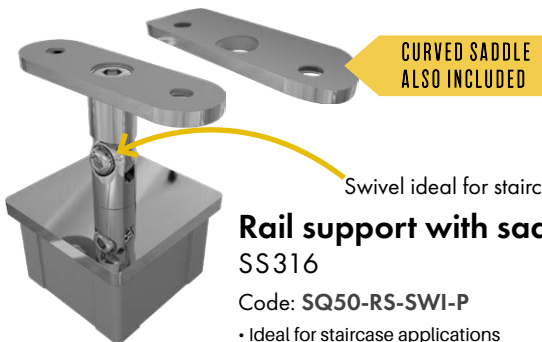

Swivel ideal for staircase installs

Rail support with saddles

SS316

Code: **SQ50-RS-SWI-P**

- Ideal for staircase applications
- Curved & flat saddles included
- Tighten angle with allen key
- No need for welding rail to rail support
- Weld or rivet fitting to vertical post for secure fixing



Top cap

SS316

Code: **SQ50-HDTC-P**

- Finish a post with the matching top cap
- Use when no handrail is required
- Epoxy, weld or rivet cap to post

PARIS

SQUARE SS316 OFFSET RAIL SUPPORT

new innovation!
OFFSET HANDRAIL WITH NO WELDING REQUIRED!



Paris offset bracket

Code: **PARIS-OB-SQ-P**

Drop in post block



Sq post screw set

Code: **PARIS-PS-SQ**

HOW TO USE PARIS OFFSET RAIL SUPPORT



Drill hole in post to accommodate Paris offset bracket



Lower internal block into post - line up block with drilled hole in post



Secure block in place with washer and mounting screw



Place Paris offset bracket over mounting screw



Tighten grub screw to secure in place



Attach desired handrail support

**Rigging screw tightener**

Code: BW-RST-TOOL

- Rigging screw tightening tool
- Also can tighten threaded terminals

**Socket drive**

Code: BW-M6SOCKET

- Use to screw M6 lag eye screws into timber
- Use with standard cordless drill

**Wire rope cutter**

Code: BW-CUTTER

- Cut 7x7 or 1x19 wire with hand tool

**Hydraulic hand pump**

Code: BW-HP-1

- Suits BW-CO-630 hydraulic press
- Used for swaging wire

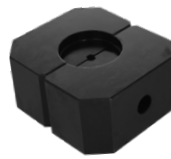
**3.2mm hex die**

Code: BW-DIE-H03

- Suits BW-CO-630 hydraulic press
- Ensures secure fixing of wire to fitting

**Hydraulic swage press**

Code: BW-CO-630

- 30t hydraulic swage press

**Rivet nut hand tool**

Code: RIV-TOOL

- Allows for quick insertion of stainless steel nutserts into posts
- Pack includes M4, M5, M6, M8 & M10 right threaded mandrel set
- Adjust stroke for different wall thickness on posts (0.5mm to 3mm)

**M6 left hand threaded mandrel**

Code: RIV-M6-LHM

- Use with RIV-TOOL for left hand threaded nutsert (BW-M6RIVNUT-L)
- Mandrel included with rivet nut hand tool is right threaded only - if installing left threaded nutserts, a left threaded mandrel is required

**M6 right hand threaded mandrel**

Code: RIV-M6-RHM

- Use with RIV-TOOL for right hand threaded nutsert (BW-M6RIVNUT-R)
- Mandrel included with rivet nut hand tool is right threaded - purchase separately if extra right hand threaded M6 mandrel is required



Read instructions prior to use to ensure tool functions correctly

**Hand swage tool**

Code: BW-HST

- Commonly used for hand swaging 7x7 wire with thimble and ferrule fittings

**Devcon 2 part epoxy 25ML**

Code: DEV-EPOXY

- Resealable syringe
- Mixing tray and stick included

**Ultraloc Threadlocker 3242 compound 10ML**

Code: ULTRALOC-3242

- Medium strength removable grade threadlocking compound for metal screws, nuts and fasteners from 6mm to 20mm in diameter



Common examples of configurations for swaged wire
- All available with cut to size service -

Rigging screw & fork terminal

Start/end point fixing

- 1 Eye screw
- 2 Lag eye screw
- 3 Saddle

Start/end point fixing

- 1 Eye screw
- 2 Lag eye screw
- 3 Saddle

Labels: Rigging screw, 1x19 wire, Fork terminal

Rigging screw & swageless fork terminal

Start/end point fixing

- 1 Eye screw
- 2 Lag eye screw
- 3 Saddle

Start/end point fixing

- 1 Eye screw
- 2 Lag eye screw
- 3 Saddle

Labels: Rigging screw, 1x19 wire, Swageless fork terminal

Rigging screws

Start/end point fixing

- 1 Eye screw
- 2 Lag eye screw
- 3 Saddle

Start/end point fixing

- 1 Eye screw
- 2 Lag eye screw
- 3 Saddle

Labels: Rigging screw, 1x19 wire, Rigging screw

Lag screw threaded terminals

Ideal for: Timber posts

Labels: Lag screw threaded terminal, 1x19 wire, Lag screw threaded terminal

Threaded terminals

Ideal for:

- 1 M6 nutsert
- 2 Drilled/tapped post

Labels: Threaded terminal, 1x19 wire, Threaded terminal

Common examples of configurations for swageless or hand swaged wire
(Not available with cut to size service)

Swageless system 1

Fix into

- M6 nutsert
- M6 tapped post
- Breezewire right hand tapped post

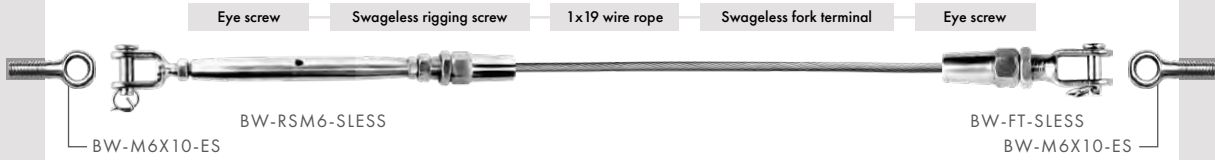

Fix into

- M6 nutsert
- M6 tapped post
- Breezewire right hand tapped post

Swageless system 2

Fix into

- Timber posts



Fix into

- Timber posts

Swageless system 3

Fix into

- Steel posts
- Stainless steel posts
- Timber posts
- Aluminium posts

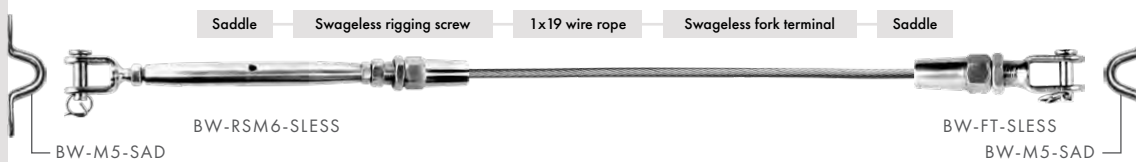

Fix into

- Steel posts
- Stainless steel posts
- Timber posts
- Aluminium posts

HAND SWAGING

Swageless system 4

Fix into

- Steel posts
- Stainless steel posts
- Timber posts
- Aluminium posts

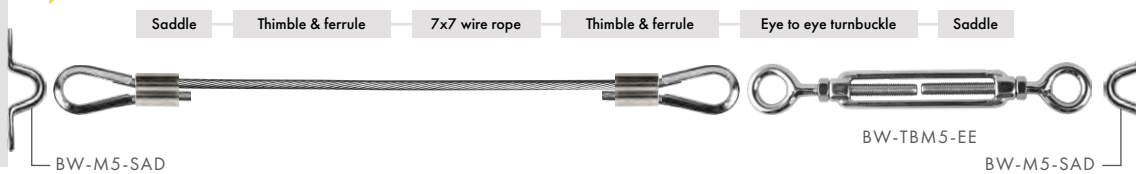

Fix into

- Steel posts
- Stainless steel posts
- Timber posts
- Aluminium posts

WIRE FITTINGS - 4 PACKS

4 packs of fittings

A range of popular wire fittings are stocked in convenient packs of 4. Each pack is heat sealed in a barcoded polybag



SWAGELESS



Swageless rigging screw

SS316 / 4 PACK

Code: RBW-RSM6-SLESS-4PK

SWAGELESS



Swageless fork terminal

SS316 / 4 PACK

Code: RBW-FT-SLESS-4PK



Rigging screw

SS316 / 4 PACK

Code: RBW-RSM5-3.2-4PK



Fork terminal

SS316 / 4 PACK

Code: RBW-FTM5-3.2-4PK



Eye screw

SS316 / 4 PACK

Code: RBW-M6X10-ES-4PK



Lag eye screw

SS316 / 4 PACK

Code: RBW-M6X60-LS-4PK



5mm saddle

SS316 / 4 PACK

Code: RBW-M5-SAD-4PK