

BLITZ GLASS

Hardware Versatilt



www.blitzglass.com.au



(07) 5493 9779



admin@blitzglass.com.au

VERSATILT ALUMINIUM

The Versatilt aluminium channel system with glass tilt adjustability sets the new standard for face mount and deck mount channel installations.

Channels available in clear anodised finish at 4200mm long with pre-drilled fixing holes suitable for either face mount or deck mount installation. Covers simply snap on to conceal all fixings. In a massive technical advancement, the patented rotator plates allow friction fitting and **TILT ADJUSTMENT** of glass inside the channel.

The Versatilt channel is perfect for pool fence installations and particularly face mount situations.

- Suits 12mm to 15mm toughened glass (including SGP toughened laminate glass)
- Channel finish is clear anodised – Covers available in brushed satin anodised or mill finish
- Face mount & deck mount styles available – 4200mm long
- Pre-machined elongated fixing holes
- Easy snap-on covers hide all fixings
- Highest quality complete channel system + easy to install!
- For corner installations there is no need to mitre cut the channel itself.
- Simply cut covers for easy installation – Channel can butt join and be hidden by covers
- For pool fencing applications, use our 1350mm high 'Clear glaze' glass (See page 12)

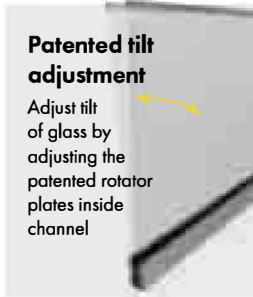

Patented tilt adjustment

Adjust tilt of glass by adjusting the patented rotator plates inside channel



*Please take care to refer to relevant standards to ensure our Versatilt system is suitable for your needs as each installation situation/compliance requirement is unique

Face mount

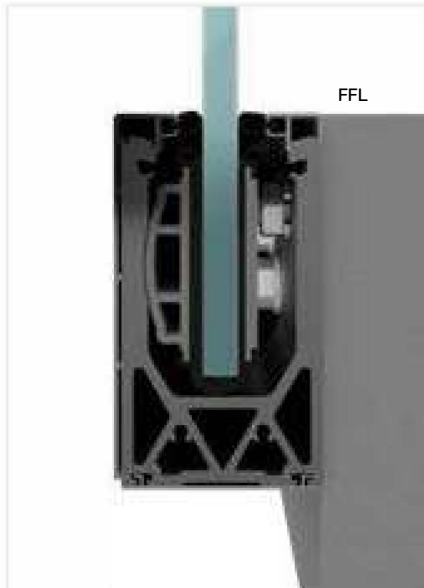

NOTE: When installing Versatilt as face mount, consider using our 1350mm high 'Clear glaze' glass to achieve height required for pool fencing

Deck mount

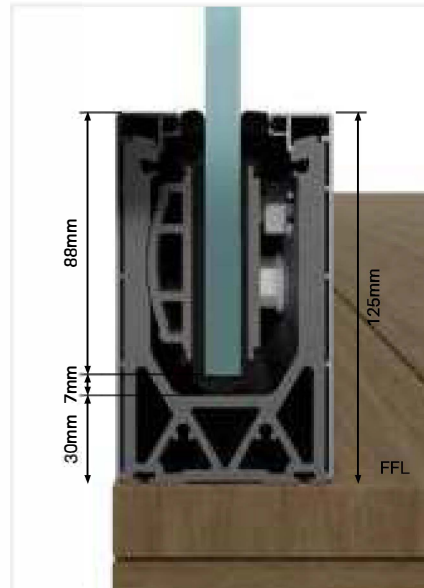

NOTE: When installing Versatilt as deck mount, you must contact your local glass supplier for a custom made gate (not stocked by Glass Outlet)

Concealed in deck

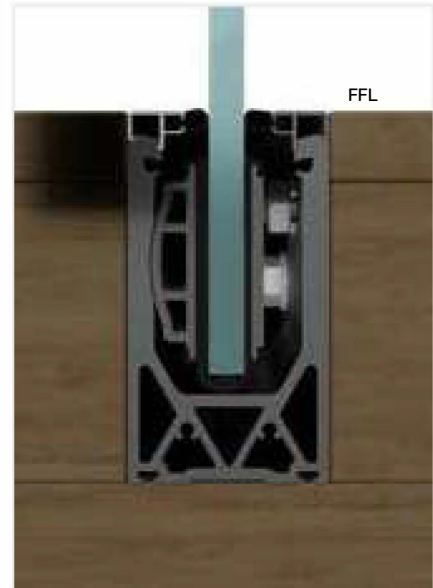

NOTE: Ensure adequate water drainage points! Not suitable for concrete slab concealing due to potential water retention

We want to make your job easier.

View our trade focused online installation videos for in-depth info on this revolutionary channel system

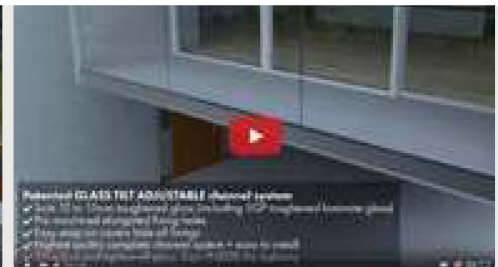
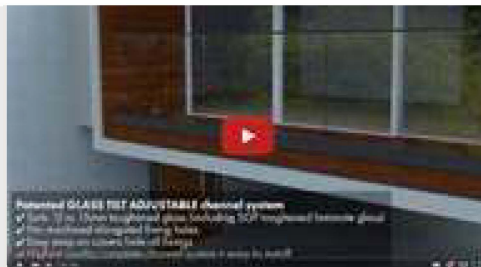

VERSATILT ALUMINIUM



Face mount channel kit

Mill or brushed satin finish
Order Code: VER-4200-FMK-M
VER-4200-FMK-SA

- Clear anodise aluminium 4200mm long channel (6063 - T6)
- Mill or brushed satin finish aluminium 4450mm long covers (6463 - T5)
- Pre-machined elongated fixing holes in channel
- 1x full cover, 1x top cover & 1x bottom cover



Face mount end plates

Mill or brushed satin finish
Order Code: VER-2FMEP-M
VER-2FMEP-SA

- 2x machined aluminium end plates (6063 - T5)
- Suits face mount channel
- Mill or brushed satin finish
- 4x SS316 panhead screws



Deck mount channel kit

Mill or brushed satin finish
Order Code: VER-4200-DMK-M
VER-4200-DMK-SA

- Clear anodise aluminium 4200mm long channel (6063 - T6)
- Mill or brushed satin finish aluminium 4450mm long covers (6463 - T5)
- Pre-machined elongated fixing holes in channel
- 2x full covers & 2x top covers (discard covers not required)



Deck mount end plates

Mill or brushed satin finish
Order Code: VER-2DMEP-M
VER-2DMEP-SA

- 2x machined aluminium end plates (6063 - T5)
- Suits deck mount channel
- Mill or brushed satin finish
- 4x SS316 panhead screws



Pressure plate kit

Order Code: VER-PPKIT

- Suits 12mm thick glass
- Use 4x plate kits per pool panel



Top infill

Order Code: VER-0300-TI

- 300mm long - cut as required
- EPDM black rubber
- Position between glass in channel



Alignment pins

Order Code: VER-PINS

- SS316 - 10 pack
- Use to join inline channels together



2 PACK

12mm glazing rubber

Order Code: VER-12KIT-RUB-2PK

- Pack of 2 lengths of glazing rubber to suit 12mm glass
- Optional spare part

Using 15mm thick glass?

You'll need these.



15mm U gasket kit

Order Code: VER-15KIT-GAS

- Pack of 6 gaskets
- Thin U gasket to use with 14.28mm and 15mm thick glass
- Use with VER-PP-KIT: Simply discard standard U gasket



15mm glazing rubber kit

Order Code: VER-15KIT-RUB

- Includes 2x 4450mm (R2 & R14 bulb) rubbers to suit Versatilt covers
- Simply discard standard rubbers supplied with covers

OVERALL DIMENSIONS

DECK MOUNT

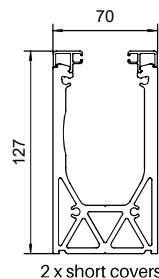
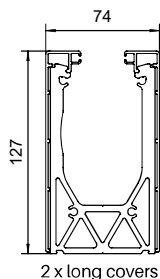

FACE MOUNT

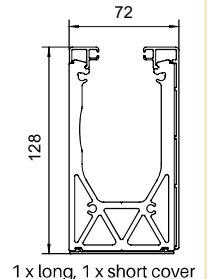

Please consult your engineer regarding suitability and structural integrity of the substrate as this will vary for each installation situation. We are unable to provide technical advice regarding suitability of substrate or fixings.

VERSATILT ALUMINIUM

HOW TO ORDER

1 SELECT CHANNEL FIXING METHOD

FACE MOUNT VER-4200-FMK KIT INCLUDES: 1x 4200mm channel 1x 4450mm side cover 1x 4450mm top cover 1x 4450mm bottom infill 2x 4450mm glazing rubbers	OR	DECK MOUNT or CONCEALED IN DECK VER-4200-DMK KIT INCLUDES: 1x 4200mm channel 2x 4450mm side cover 2x 4450mm top cover 2x 4450mm glazing rubbers
---	----	---

2 SELECT FINISH

SATIN ANODISED
OR
MILL ALUMINIUM

3 SELECT PRESSURE PLATE KIT

12MM GLASS KIT VER-PPKIT KIT INCLUDES: 1x U gasket 1x curve plate 1x pressure plate 2x M12 nuts	OR	15MM GLASS KIT VER-PPKIT + VER-15KIT-GAS KIT INCLUDES: 12mm glass kit PLUS 6x U gaskets to suit 15mm glass
---	----	---

4 ADD MISC. EXTRAS

DECK MOUNT END PLATES VER-2DMEP: 2x end plates & 4x screws
FACE MOUNT END PLATES VER-2FMEP: 2x end plates & 4x screws
TOP INFILL DIVIDERS VER-0300-TI: 300mm long
JOINING PINS VER-PINS: Pack of 10
RUBBER FOR 15MM GLASS VER-15KIT-RUB: 1x R2 rubber & 1x R14 rubber



VERSATILT ALUMINIUM

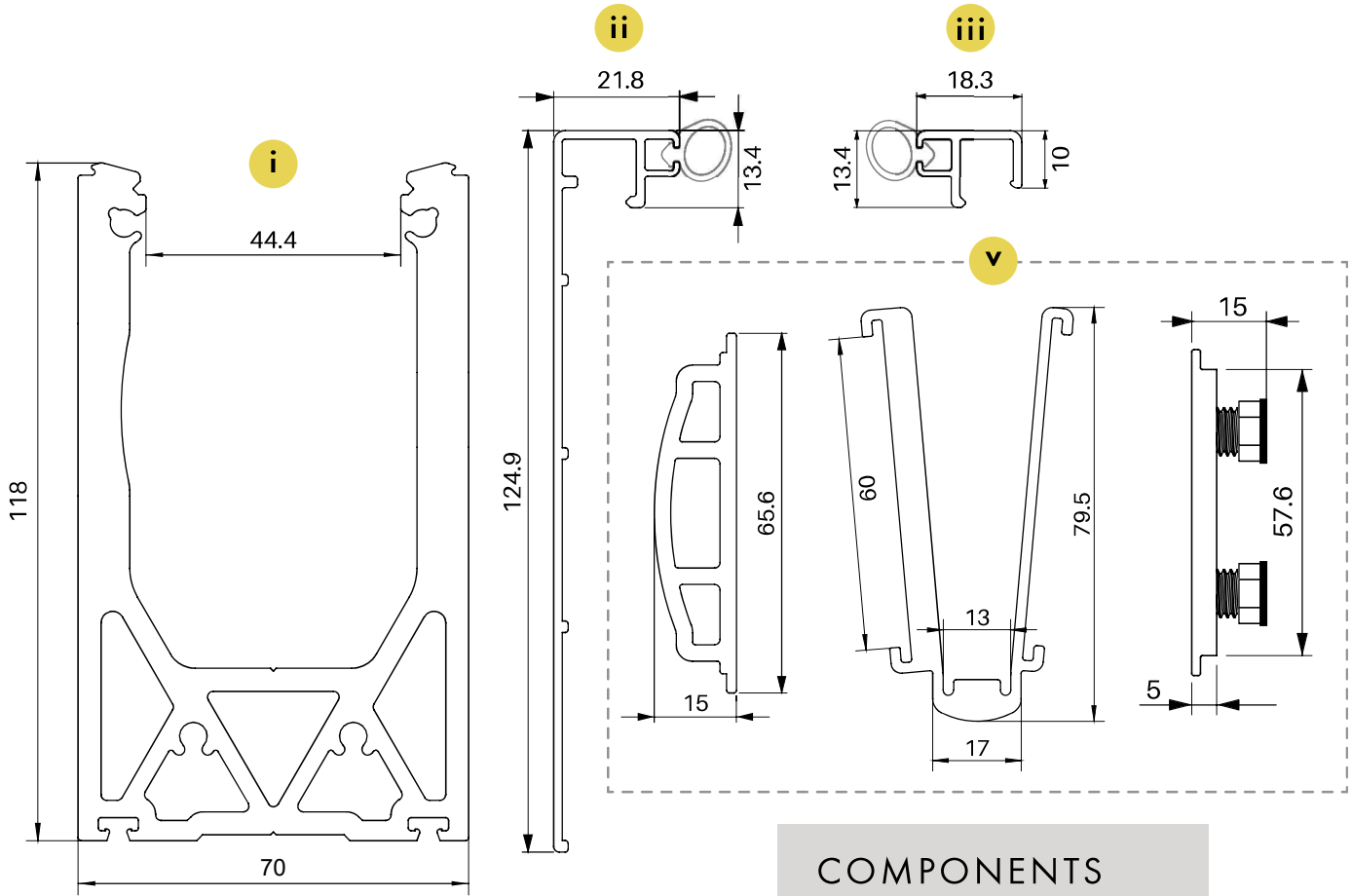

COMPONENTS

- i** Versatilt channel
- ii** Side mount snap-on cover
- iii** Top mount snap-on cover
- iv** Bottom infill
- v** Pressure plate kit:
 - Curve plate
 - Rubber gasket
 - Pressure plate

HOLE MACHINING DETAIL

