

POST SYSTEM OVERVIEW

Stylish design with fast and easy installation – no welding or riveting required

BUILD ON-SITE WITH FAST & EASY INSTALL

Install pre-powder coated 50x50mm posts (core drill or base plated) and insert slats working from bottom to top.



BENEFITS & FEATURES —

- Assemble on-site with pre-powder coated posts and slats
- 1 way, 2 way and 90° post configurations available
- Patented friction fitting of slats into posts – no need to weld, screw or rivet slats
- Variable slat spacing – 5mm, 9mm and 20mm spacers available or customise slat spacing by cutting down 100mm spacer blocks. Nil spacing can be achieved by simply stacking slats with no gap
- The starting height of first slat is set by simply snapping in infill

- 1 Press-in aluminium top plate
- 2 Slat locking clip
- 3 65mm x 16.5mm slats (90mm x 16.5mm slats also available)
- 4 Snap-in spacers
- 5 Patented 50x50mm post
- 6 100mm high spacer block (cut down to adjust first slat starting height)

**AUSTRALIAN MADE
& POWDER COATED
ALUMINIUM**

SLATS RECESS INTO PATENTED FRICTION FIT POSTS FOR A NEAT FINISH



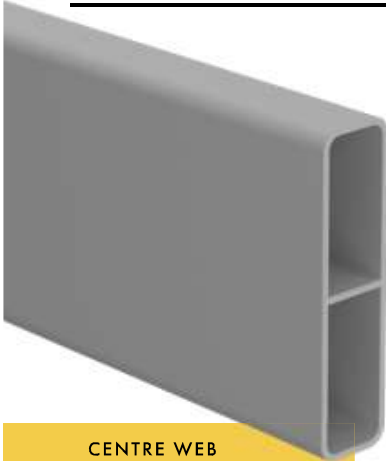

CENTRE WEB
ADDS STRENGTH &
RIGIDITY TO SLAT

**65mm x 16.5mm slat
with centre web**

6100MM LONG

Order Code: XP-6100-S65

SOLD AS SINGLE LENGTHS,
BUNDLES OR PACK LOTS

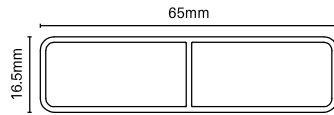

TECH SPECS

- PP 157 / AP 157
- Alloy 6063-T6
- 6100mm long
- 1.2mm wall thickness with centre web
- 3.5mm radius corners
- Genuine Australian Interpon powder coat
- lxx = 9.60 x 10E3 mmE4
- lyy = 83.09 x 10E3 mmE4

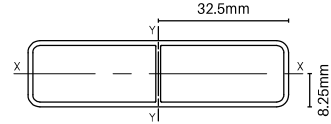

Finishes



BUY IN PACK LOTS
FOR BEST PRICING!

65mm x 16.5mm slat

6500MM LONG

Order Code: XP-6500-E65

SOLD IN PACKS OF 96 ONLY
Not sold as single lengths

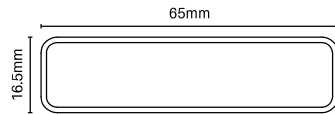

TECH SPECS

- PP 157 / AP 157
- Alloy 6063-T6
- 6500mm long
- 1.2mm wall thickness
- 3.5mm radius corners
- Genuine Australian Interpon powder coat
- lxx = 9.31 x 10E3 mmE4
- lyy = 83.09 x 10E3 mmE4

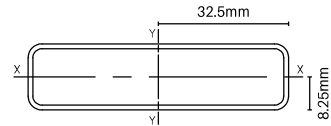

Finishes



CENTRE WEB
ADDS STRENGTH &
RIGIDITY TO SLAT

**90mm x 16.5mm slat
with centre web**

6100MM LONG

Order Code: QS-6100-S90

SOLD AS SINGLE LENGTHS,
BUNDLES OR PACK LOTS

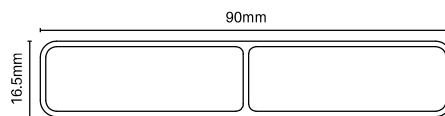

TECH SPECS

- PP 208 / AP 208
- Alloy 6063-T6
- 6100mm long
- 1.2mm wall thickness with centre web
- 3mm radius corners
- Genuine Australian Interpon powder coat
- lxx = 13.28 x 10E3 mmE4
- lyy = 202.57 x 10E3 mmE4

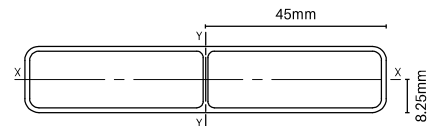

Finishes



POST SYSTEM EXTRUSIONS



PATENTED FRICTION FIT SYSTEM

One way post

6000MM LONG

Order Code: XPL-6000-1W

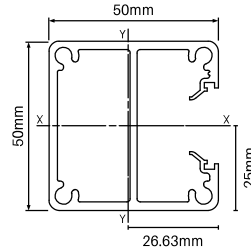

TECH SPECS

- PP 200 / AP 360
- Alloy 6060-T5
- 6000mm long
- 2.5mm wall thickness
- Patented friction legs for non-weld slat assembly
- Maximum slat insertion depth = 24mm
- lxx = 196.53 x 10E3 mmE4
- lyy = 155.26 x 10E3 mmE4

4x screw flutes in post allow tight fit of press in flat aluminium top plate. Top plate sold separately

Optional base plate can be attached using screw flutes for base plated post installations.

Finishes



PATENTED FRICTION FIT SYSTEM

Two way post

6000MM LONG

Order Code: XPL-6000-2W

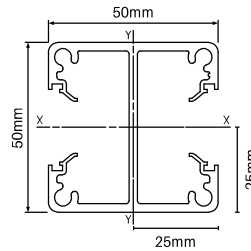

TECH SPECS

- PP 200 / AP 523
- Alloy 6060-T5
- 6000mm long
- 2.5mm wall thickness
- Patented friction legs for non-weld slat assembly
- Maximum slat insertion depth = 24mm
- lxx = 200.75 x 10E3 mmE4
- lyy = 132.93 x 10E3 mmE4

4x screw flutes in post allow tight fit of press in flat aluminium top plate. Top plate sold separately

Optional base plate can be attached using screw flutes for base plated post installations.

Finishes



PATENTED FRICTION FIT SYSTEM

90° corner post

6000MM LONG

Order Code: XPL-6000-90

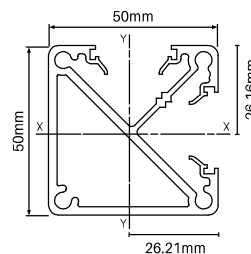

TECH SPECS

- PP 200 / AP 413
- Alloy 6060-T5
- 6000mm long
- 2.5mm wall thickness
- Patented friction legs for non-weld slat assembly
- Maximum slat insertion depth = 15mm
- lxx = 177.32 x 10E3 mmE4
- lyy = 176.23 x 10E3 mmE4

4x screw flutes in post allow tight fit of press in flat aluminium top plate. Top plate sold separately

Optional base plate can be attached using screw flutes for base plated post installations.

Finishes



POST SYSTEM EXTRUSIONS



50x50mm full post

2400MM OR 6000MM LONG

Order Code: XP-2400/6000-FP

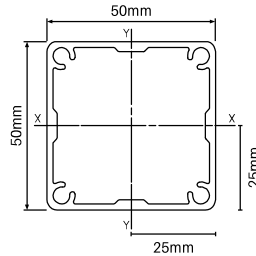

TECH SPECS

- PP 195 / AP 195
- Alloy 6063 - T6
- 1.8mm wall thickness with 3mm ribs
- Aluminium powder coated press-in top plate included with 2400mm posts
- lxx = 170.44 x 10E3 mmE4
- lyy = 170.44 x 10E3 mmE4

4x screw flutes in post allow tight fit of press in flat aluminium top plate.

Optional base plate can be attached using screw flutes for base plated post installations.

Finishes

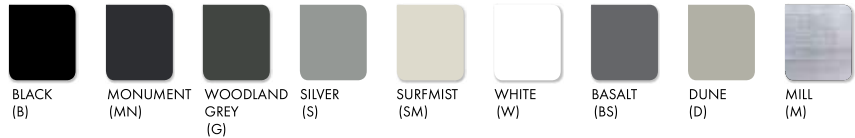

Centre support rail

5800MM LONG

Order Code: XP-5800-CSR

OPTIONAL EXTRA

Commonly used for screens 2000mm or wider to provide strength & rigidity to panel

Snap-on cover hides fixings – provides slimline sturdy support rail with no visible fixings

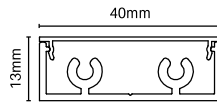

TECH SPECS

- PP 126 / AP 188
- Alloy 6063-T5
- 5800mm long
- Screw fix centre support rail to each slat
- Includes 2x screw flutes for press-in top cap
- Top cap sold separately
- lxx = 1.73 x 10E3 mmE4
- lyy = 26.34 x 10E3 mmE4

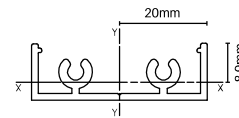

Finishes



2 PART CENTRE SUPPORT RAIL



Centre support rail cap

40mm x 13mm

3MM THICK

Order Code: XP-CSRC

- Nylon cap available in 5 colours
- Simply press into screw flutes in centre support rail
- Easy and fast fitting of cap

MATES WITH XP-5800-CSR

Finishes



Centre support rail top/bottom plate

Order Code: XP-BTP

- Aluminium with countersunk hole machining
- 2x CSK screws included for fixing to CSR
- Optional extra to install with centre support rail
- Use to brace top and/or bottom of centre support rail to structure above or below if desired
- Bracing centre support rail provides extra rigidity to panels - recommended for wide screens
- Available in same colours as centre support rail

MATES WITH XP-5800-CSR



Screw top/bottom plate to centre support rail



Screw through central hole to substrate at top or bottom

SPACERS & EXTRAS



50 PACK Spacer blocks

5MM, 9MM OR
20MM SPACERS

Order Code: **XPL-SB-50PK-05MM**
XPL-SB-50PK-09MM
XPL-SB-50PK-20MM

- UV stabilised ASA thermoplastic - black
- Snaps into Xpress Plus post
- Provides 5mm, 9mm or 21mm space between slats
- Fast and easy install with post, slats and spacers

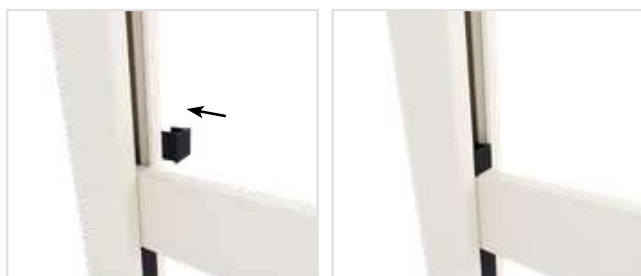

5 PACK Block

100MM or 1000MM LONG

Order Code: **XPL-BLOCK-5PK**
XPL-1000-BLOCK

- UV stabilised ABS - black
- Snaps into Xpress Plus post pocket
- Use to set starting height of first slat in post. Simply cut to starting height & snap into position at bottom of post
- Can also be cut to size to customise slat spacing



10 PACK Slat locking clip

Order Code: **XPL-SLATCLIP-10PK**

- Aluminium locking clip with SS304 self tapping screws
- Affix to both sides of top slat only between each fence post opening
- Acts as mechanical fix to prevent chance of posts splaying open
- Allow 5mm gap between top of final slat and top of post
- Locking clip hidden under post top plate



Self drilling wafer screws

10Gx16mm – BAG OF 100
Black / Monument / Woodland Grey / Silver / Surfmist / White Basalt / Dune / Mill finish

Order Code: **XP-SCREWS**

- Bags of 100 - 10G x 16mm self drilling wafer head zinc plated
- Colour matched powder coated heads
- Not required for post/slat assembly. Screws useful if needing to screw fix centre support rail to slat, U channel, angle or similar for an installation



Touch up paint

150g SPRAY CAN
Black / Monument / Woodland Grey / Silver / Surfmist / White Basalt / Dune

Order Code:
PAINT-B/MN/G/S/SM/W/BS/D

- Colour matched touch up paint
- Simply spray on for minor touch ups

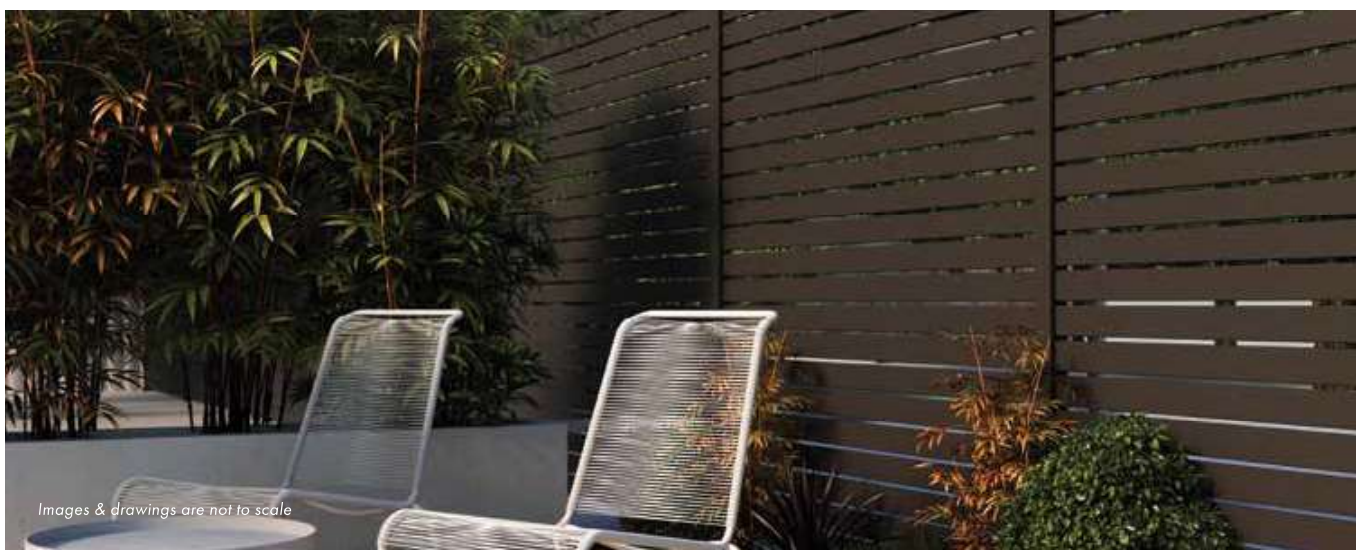

Images & drawings are not to scale

END PLATES & BASE PLATES



50x50mm post flat top plate

POWDER COATED ALUMINIUM
**Black / Monument / Woodland Grey
 Silver / Surfmist / White / Basalt
 Dune / Mill finish**

Order Code: XP-TP

- Alloy ADC12 aluminium plate - 3mm thick
- Press into post screw flutes for secure fixing
- Suits fitting to all 50x50mm Xpress Plus posts

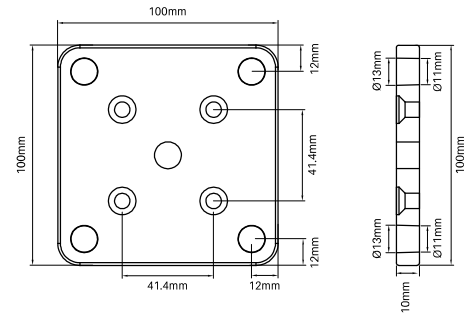

50x50mm post dress ring

POWDER COATED ALUMINIUM
**Black / Monument / Woodland Grey
 Silver / Surfmist / White / Basalt
 Dune / Mill finish**

Order Code: XP-DR

- Suits 50x50mm core drill posts
- 100mm x 100mm outer - 52mm x 52mm inner

50x50mm post base plate set

1 x base plate & 4 x screws

POWDER COATED ALUMINIUM
**Black / Monument / Woodland Grey / Silver
 Surfmist / White / Basalt / Dune / Mill finish**

Order Code: XP-BP-SET

- 100mm x 100mm base plate (10mm thick) with 4x fixing holes
- Simply screw base plate into core drill post screw flutes
- 4x 12G x 50mm long CSK screws (SS304) included in set

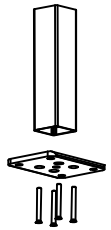

Discreet screws fix two parts of cover together

Two part domical cover

POWDER COATED ALUMINIUM
**Black / Monument / Woodland Grey
 Silver / Surfmist / White / Basalt
 Dune / Mill finish**

Order Code: XP-DC-2P

- Suits 50x50mm post with screw fixed base plate
- 106x106mm outer - 52x52mm inner - Alloy ADC12
- 30mm high
- Cover can be fitted to posts after fence is installed

Finishes



Timber fixing kit

4 PACK - SS316
 Order Code: S-110LAG-4PK

- M10 x 110mm timber lag screws x4 with nuts and washers
- Suits fixing holes in both the 50x50mm and 65x65mm base plate sets



Concrete fixing kit

4 PACK - SS316
 Order Code: S-120ROD-4PK

- M10 x 120mm concrete threaded rods x4 with nuts and washers
- Suits fixing holes in both the 50x50mm and 65x65mm base plate sets

POSTS & ACCESSORIES



65x65mm heavy duty post

2400MM or 6000MM LONG

Order Code: XP-2400/6000-65HD

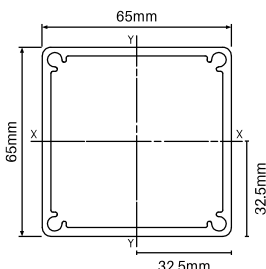

TECH SPECS

- PP 255 / AP 255
- 65x65mm larger profile, heavy duty post
- Alloy 6063 - T6
- 3mm wall thickness
- Screw flutes to screw on base plate if required
- Aluminium powder coated press-in top plate included with 2400mm posts
- lxx = 464.62 x 10E3 mmE4
- lyy = 464.62 x 10E3 mmE4

4x screw flutes in post allow tight fit of press in flat aluminium top plate.

Optional base plate can be attached using screw flutes for base plated post installations.

Finishes



65x65mm post flat top plate

POWDER COATED ALUMINIUM

Black / Monument / Woodland Grey / Silver / Surfmist
White / Basalt / Dune / Mill finish

Order Code: XP-65TP

- Alloy ADC12 aluminium plate - 3mm thick
- Press into post screw flutes for secure fixing
- 2400mm posts come with free top plate included - only purchase if extra top plates are required
- Top plates required for 6000mm posts - sold separately

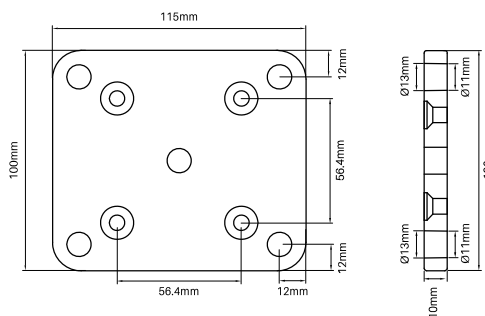

Discreet screws fix two parts of cover together

65x65mm two part domical cover

POWDER COATED ALUMINIUM
Black / Monument / Woodland Grey
Silver / Surfmist / White / Basalt
Dune / Mill finish

Order Code: XP-65DC-2P

- Suits 65x65mm post with screw fixed base plate
- 122x106mm outer - 67x67mm inner - Alloy ADC12
- 30mm high
- Cover can be fitted to posts after fence is installed



65x65mm post dress ring

POWDER COATED ALUMINIUM

Black / Monument / Woodland Grey / Silver / Surfmist
White / Basalt / Dune / Mill finish

Order Code: XP-65DR

- Suits 65x65mm heavy duty post
- 115mm x 115mm outer - 67mm x 67mm inner

65x65mm post base plate set

1x base plate & 4x screws

POWDER COATED ALUMINIUM

Black / Monument / Woodland Grey / Silver
Surfmist / White / Basalt / Dune / Mill finish

Order Code: XP-65BP-SET

- 115mm x 100mm base plate (10mm thick) with 4x fixing holes
- Simply screw base plate into core drill post screw flutes
- 4x 12G x 50mm long CSK screws (SS304) included in set

Finishes

